

CE EMC Test Report

Report No.: CE160127D11-1

Test Model: ECS-8000-PoE

Series Model: Vecow ECS-8000 Series, ECS-8000-PoER, ECS-8000-2G, ECS-8000-2R,
ECS-8XXXXXXXXXXXXXXXXXXXXX
("X" can be 0-9, A-Z or blank for marketing purpose)

Received Date: Jan. 27, 2016

Test Date: Feb. 17 ~ Mar. 16, 2016

Issued Date: Mar. 21, 2016

Applicant: Vecow Co., Ltd.

Address: 12F., No. 111, Zhongcheng Rd., Tucheng Dist., New Taipei City 23674
Taiwan (R.O.C.)

Issued By: Bureau Veritas Consumer Products Services (H.K.) Ltd., Taoyuan Branch

Lab Address: No. 47-2, 14th Ling, Chia Pau Vil., Lin Kou Dist., New Taipei City, Taiwan
(R.O.C.)



LAB CODE: 200836-0



This report is for your exclusive use. Any copying or replication of this report to or for any other person or entity, or use of our name or trademark, is permitted only with our prior written permission. This report sets forth our findings solely with respect to the test samples identified herein. The results set forth in this report are not indicative or representative of the quality or characteristics of the lot from which a test sample was taken or any similar or identical product unless specifically and expressly noted. Our report includes all of the tests requested by you and the results thereof based upon the information that you provided to us. You have 60 days from date of issuance of this report to notify us of any material error or omission caused by our negligence, provided, however, that such notice shall be in writing and shall specifically address the issue you wish to raise. A failure to raise such issue within the prescribed time shall constitute your unqualified acceptance of the completeness of this report, the tests conducted and the correctness of the report contents. Unless specific mention, the uncertainty of measurement has been explicitly taken into account to declare the compliance or non-compliance to the specification. The report must not be used by the client to claim product certification, approval, or endorsement by NVLAP, NIST, or any agency of the federal government. The report must not be used by the client to claim product certification, approval, or endorsement by TAF or any government agencies.

Table of Contents

Release Control Record	5
1 Certificate of Conformity	6
2 Summary of Test Results	7
2.1 Measurement Uncertainty.....	8
2.2 Modification Record.....	8
3 General Information	9
3.1 Features of EUT.....	9
3.2 General Description of EUT.....	9
3.3 Operating Modes of EUT and Determination of Worst Case Operating Mode.....	10
3.4 Test Program Used and Operation Descriptions.....	11
3.5 Primary Clock Frequencies of Internal Source	11
4 Configuration and Connections with EUT	12
4.1 Connection Diagram of EUT and Peripheral Devices	12
4.2 Configuration of Peripheral Devices and Cable Connections.....	14
5 Conducted Disturbance at Mains Ports	16
5.1 Limits	16
5.2 Test Instruments.....	16
5.3 Test Arrangement.....	17
5.4 Test Results.....	18
6 Conducted Disturbance at Telecommunication Ports	20
6.1 Limits	20
6.2 Test Instruments.....	20
6.3 Test Arrangement.....	21
6.4 Supplementary Information.....	21
6.5 Test Results	22
7 Radiated Disturbance up to 1 GHz	30
7.1 Limits	30
7.2 Test Instruments.....	30
7.3 Test Arrangement.....	31
7.4 Test Results.....	32
8 Radiated Disturbance above 1 GHz	34
8.1 Limits	34
8.2 Test Instruments.....	34
8.3 Test Arrangement.....	35
8.4 Test Results.....	36
9 Harmonics Current Measurement	38
9.1 Limits	38
9.2 Classification of Equipment.....	38
9.3 Test Instruments.....	38
9.4 Test Arrangement.....	39
9.5 Test Results.....	40
10 Voltage Fluctuations and Flicker Measurement	41
10.1 Limits	41
10.2 Test Instruments.....	41
10.3 Test Arrangement.....	41
10.4 Test Results.....	42

11	General Immunity Requirements	43
11.1	Performance Criteria	44
12	Electrostatic Discharge Immunity Test (ESD).....	45
12.1	Test Specification.....	45
12.2	Test Instruments	45
12.3	Test Arrangement	45
12.4	Test Results.....	47
13	Radiated, Radio-frequency, Electromagnetic Field Immunity Test (RS).....	50
13.1	Test Specification.....	50
13.2	Test Instruments	50
13.3	Test Arrangement	51
13.4	Test Results.....	52
14	Electrical Fast Transient/Burst Immunity Test (EFT).....	53
14.1	Test Specification.....	53
14.2	Test Instruments	53
14.3	Test Arrangement	54
14.4	Test Results.....	55
15	Surge Immunity Test.....	56
15.1	Test Specification.....	56
15.2	Test Instruments	56
15.3	Test Arrangement	57
15.4	Test Results.....	59
16	Immunity to Conducted Disturbances Induced by RF Fields (CS).....	60
16.1	Test Specification.....	60
16.2	Test Instruments	61
16.3	Test Arrangement	62
16.4	Test Results.....	63
17	Power Frequency Magnetic Field Immunity Test	64
17.1	Test Specification.....	64
17.2	Test Instruments	64
17.3	Test Arrangement	64
17.4	Test Results.....	65
18	Voltage Dips and Interruptions.....	66
18.1	Test Specification.....	66
18.2	Test Instruments	66
18.3	Test Arrangement	66
18.4	Test Results.....	67
19	Pictures of Test Arrangements.....	68
19.1	Conducted Disturbance at Mains Ports	68
19.2	Conducted Disturbance at Telecommunication Ports.....	69
19.3	Radiated Disturbance up to 1 GHz	71
19.4	Radiated Disturbance above 1 GHz.....	72
19.5	Harmonics Current, Voltage Fluctuations and Flicker Measurement	73
19.6	Electrostatic Discharge Immunity Test (ESD)	73
19.7	Radio-frequency, Electromagnetic Field Immunity Test (RS)	74
19.8	Electrical Fast Transient/Burst Immunity Test (EFT)	75
19.9	Surge Immunity Test.....	77
19.10	Conducted Disturbances Induced by RF Fields (CS)	78
19.11	Power Frequency Magnetic Field Immunity Test (PFMF).....	80



19.12 Voltage Dips and Interruptions	80
Appendix – Information on the Testing Laboratories	81



Release Control Record

Issue No.	Description	Date Issued
CE160127D11-1	Original release.	Mar. 21, 2016

1 Certificate of Conformity

Product: High Performance Fanless System
Brand: Vecow
Test Model: ECS-8000-PoE
Series Model: Vecow ECS-8000 Series, ECS-8000-PoER, ECS-8000-2G, ECS-8000-2R, ECS-8XXXXXXXXXXXXXXXXXXXXX ("X" can be 0-9, A-Z or blank for marketing purpose)
Sample Status: Engineering sample
Applicant: Vecow Co., Ltd.
Test Date: Feb. 17 ~ Mar. 16, 2016
Standards: **EN 55022:2010 +AC:2011, Class A**
CISPR 22:2008, Class A
AS/NZS CISPR 22:2009 +A1:2010, Class A
EN 61000-3-2:2014
EN 61000-3-3:2013
EN 55024:2010
EN 61000-4-2:2009 / IEC 61000-4-2:2008 ED. 2.0
EN 61000-4-3:2006 +A1:2008 +A2:2010 / IEC 61000-4-3:2010 ED. 3.2
EN 61000-4-4:2012 / IEC 61000-4-4:2012 ED. 3.0
EN 61000-4-5:2014 / IEC 61000-4-5:2014 ED. 3.0
EN 61000-4-6:2014 / IEC 61000-4-6:2013 ED. 4.0
EN 61000-4-8:2010 / IEC 61000-4-8:2009 ED. 2.0
EN 61000-4-11:2004 / IEC 61000-4-11:2004 ED. 2.0

The above equipment has been tested by **Bureau Veritas Consumer Products Services (H.K.) Ltd., Taoyuan Branch**, and found compliance with the requirement of the above standards. The test record, data evaluation & Equipment Under Test (EUT) configurations represented herein are true and accurate accounts of the measurements of the sample's EMC characteristics under the conditions specified in this report.

Prepared by :  , **Date:** Mar. 21, 2016
Celia Chen / Supervisor

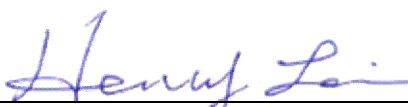
Approved by :  , **Date:** Mar. 21, 2016
Henry Lai / Director

2 Summary of Test Results

Emission				
Standard	Clause	Test Item	Result/Remarks	Verdict
EN 55022:2010 +AC:2011 / CISPR 22:2008 / AS/NZS CISPR 22:2009 +A1:2010	5.1	Mains terminal disturbance voltage	Minimum passing Class A margin is -11.50 dB at 2.90695 MHz	Pass
	5.2	Conducted common mode (asymmetric mode) disturbance at telecommunication ports	Minimum passing Class A margin is -11.39 dB at 1.12109 MHz	Pass
	6.1	Radiated disturbance 30-1000 MHz	Minimum passing Class A margin is -4.20 dB at 82.50 MHz	Pass
	6.2	Radiated disturbance above 1GHz	Minimum passing Class A margin is -7.01 dB at 2227.80 MHz	Pass
EN 61000-3-2:2014	-	Harmonic current emissions	The power consumption of EUT is less than 75W and no limits apply.	Pass
EN 61000-3-3:2013	-	Voltage fluctuations and flicker	$P_{st} \leq 1.0$ $d_{max} \leq 4\%$ $P_{it} \leq 0.65$ $d_c \leq 3.3\%$ $T_{max} \leq 500ms$	Pass

Immunity				
EN 55024 Clause	Basic standard	Test Item	Result/Remarks	Verdict
4.2.1	EN 61000-4-2:2009 / IEC 61000-4-2:2008 ED. 2.0	Electrostatic discharges (ESD)	Performance Criterion B	Pass
4.2.3.2	EN 61000-4-3:2006 +A1:2008 +A2:2010 / IEC 61000-4-3:2010 ED. 3.2	Continuous radiated disturbances (RS)	Performance Criterion A	Pass
4.2.2	EN 61000-4-4:2012 / IEC 61000-4-4:2012 ED. 3.0	Electrical fast transients (EFT)	Performance Criterion A	Pass
4.2.5	EN 61000-4-5:2014 / IEC 61000-4-5:2014 ED. 3.0	Surges	Performance Criterion A	Pass
4.2.3.3	EN 61000-4-6:2014 / IEC 61000-4-6:2013 ED. 4.0	Continuous conducted disturbances (CS)	Performance Criterion A	Pass
4.2.4	EN 61000-4-8:2010 / IEC 61000-4-8:2009 ED. 2.0	Power-frequency magnetic fields (PFMF)	Performance Criterion A	Pass
4.2.6	EN 61000-4-11:2004 / IEC 61000-4-11:2004 ED. 2.0	Voltage dips and interruptions	Voltage Dips: >95% reduction – 0.5 period, Performance Criterion A 30% reduction – 25 periods, Performance Criterion A Voltage Interruptions: >95% reduction – 250 periods, Performance Criterion C	Pass

Note:

1. There is no deviation to the applied test methods and requirements covered by the scope of this report.
2. The above EN/IEC basic standards are applied with latest version if customer has no special requirement.

2.1 Measurement Uncertainty

Where relevant, the following measurement uncertainty levels have been estimated for tests performed on the EUT as specified in CISPR 16-4-2:

The listed uncertainties are the worst case uncertainty for the entire range of measurement. Please note that the uncertainty values are provided for informational purposes only and are not used in determining the PASS/FAIL results.

Measurement	Expanded Uncertainty (k=2) (\pm)	Maximum allowable uncertainty (\pm)
Conducted disturbance at mains port using AMN, 150kHz ~ 30MHz	2.78 dB	3.4 dB (U_{CISPR})
Conducted disturbance at telecommunication port using AAN, 150kHz ~ 30MHz	3.94 dB	5.0 dB (U_{CISPR})
Radiated disturbance, 30MHz ~ 1GHz	5.20 dB	6.3 dB (U_{CISPR})
Radiated disturbance, 1GHz ~ 6GHz	3.36 dB	5.2 dB (U_{CISPR})

2.2 Modification Record

There were no modifications required for compliance.

3 General Information

3.1 Features of EUT

The tests reported herein were performed according to the method specified by Vecow Co., Ltd., for detailed feature description, please refer to the manufacturer's specifications or user's manual.

3.2 General Description of EUT

Product	High Performance Fanless System
Brand	Vecow
Test Model	ECS-8000-PoE
Series Model	Vecow ECS-8000 Series, ECS-8000-PoER, ECS-8000-2G, ECS-8000-2R, ECS-8XXXXXXXXXXXXXXXXXXXX ("X" can be 0-9, A-Z or blank for marketing purpose)
Model Difference	For marketing purpose
Sample Status	Engineering sample
Operating Software	Window 8, Window 7, Linux
Power Supply Rating	6V to 36V DC in
Accessory Device	Adapter
Data Cable Supplied	N/A

Note:

1. The EUT is a High Performance Fanless System with following interfaces:

- 2 COM*4 (RS-232/422/485)
- 2 USB 3.0*4
- 2 USB2.0*3 (External*2, Internal*1)
- 2 Isolated DIO*16 (DI*8, DO*8)
- 2 SIM card sockets*2
- 2 CFast card socket
- 2 D-Sub (resolution up to 1920 x 1200, 60Hz)
- 2 DVI (resolution up to 1920 x 1080, 60Hz)
- 2 Display*2 (resolution up to 4096 x 2304, 60Hz)
- 2 PoE LAN*4
- 2 LAN (10/100/1000Mbps)*2
- 2 Line out
- 2 Mic. in
- 2 DC input

2. The EUT was configured with the following key components:

Component	Brand	Model No. or P/N	Spec.
CPU	Intel	I7-5850 EQ	3.4GHz
Memory	Vecow	M340S-W28M1	4GB SOD PC3-10600 CL9
SSD	Memoright	EC3S2M 064GCADE7C2	64GB
CFast	Memoright	MCFA J500	32GB

3. The EUT uses following adapter.

Brand	Mean Well
Model	GS160A24
Input Power	100-240Vac, 50/60Hz, 2.0A
Output Power	24Vdc, 6.67A, 160W Max.
Power Line	Non-shielded DC (1.0m) with one ferrite core

3.3 Operating Modes of EUT and Determination of Worst Case Operating Mode

The EUT is designed with AC power of rating 100-240Vac, 50/60Hz.

For radiated emission evaluation, 230Vac/50Hz (for EN 55022 & EN 55011), 120Vac/60Hz (for FCC Part 15) had been covered during the pre-test. The worst data was found at **230Vac/50Hz** and recorded in the applied test report.

EUT has been pre-tested under following test modes, and test mode 2 was the worst case for final test.

Mode	Test Condition
1	Display1 (4096 x 2304, 60Hz) + D-Sub (1920 x 1200, 60Hz) + DVI (1920 x 1080, 60Hz)
2	Display2 (4096 x 2304, 60Hz) + D-Sub (1920 x 1200, 60Hz) + DVI (1920 x 1080, 60Hz)

Test modes are presented in the report as below.

Mode	Test Condition
Conducted emission test	
1	Full system, Display2 (4096 x 2304, 60Hz) + D-Sub (1920 x 1200, 60Hz) + DVI (1920 x 1080, 60Hz)
Conducted emission at telecom port test	
1	Full system, LAN 1 (10/100/1000Mbps)
2	Full system, LAN 2 (10/100/1000Mbps)
3	Full system, PoE LAN 4
4	Full system, PoE LAN 6
The idle mode of conducted emission test at telecom port was pre-tested based on the worst case of link mode. Due to emissions of idle mode being very low compared to link mode, only the link mode data were presented in the test report.	
Radiated emission test	
1	Full system, Display2 (4096 x 2304, 60Hz) + D-Sub (1920 x 1200, 60Hz) + DVI (1920 x 1080, 60Hz)
Harmonics, Flicker, Immunity tests	
1	Full system, Display2 (4096 x 2304, 60Hz) + D-Sub (1920 x 1200, 60Hz) + DVI (1920 x 1080, 60Hz)

3.4 Test Program Used and Operation Descriptions

Emission tests (Harmonics & Flicker excluded):

- a. Turned on the power of all equipment.
- b. EUT ran a test program to enable all functions.
- c. EUT read and wrote messages from/to HDD/SSD, CFast card and ext. HDDs.
- d. EUT sent and received messages to/from Notebook PCs (kept in a remote area) via two UTP LAN cables.
- e. EUT sent messages to ext. LCD Monitors. Then they displayed messages on their screen simultaneously.
- f. EUT sent messages to printer. Then it printed them out simultaneously.
- g. EUT sent 1kHz audio signal to earphone.
- h. Cameras captured video image to LCD Monitors via EUT.
- i. Steps c-h were repeated.

Harmonics, Flicker, Immunity tests:

- a. Turned on the power of all equipment.
- b. EUT ran a test program to enable all functions.
- c. EUT read and wrote messages from/to HDD/SSD and ext. HDDs.
- d. EUT sent and received messages to/from Notebook PCs (kept in a remote area) via two UTP LAN cables.
- e. EUT sent messages to ext. LCD Monitors. Then they displayed messages on their screen simultaneously.
- f. EUT sent 1kHz audio signal to speaker.
- g. Cameras captured video image to LCD Monitors via EUT.
- h. Steps c-g were repeated.

3.5 Primary Clock Frequencies of Internal Source

The highest frequency generated or used within the EUT or on which the EUT operates or tunes is 3400 MHz, provided by Vecow Co., Ltd., for detailed internal source, please refer to the manufacturer's specifications.

4 Configuration and Connections with EUT

4.1 Connection Diagram of EUT and Peripheral Devices

Emission tests (Harmonics & Flicker excluded):

TEST CONFIGURATION

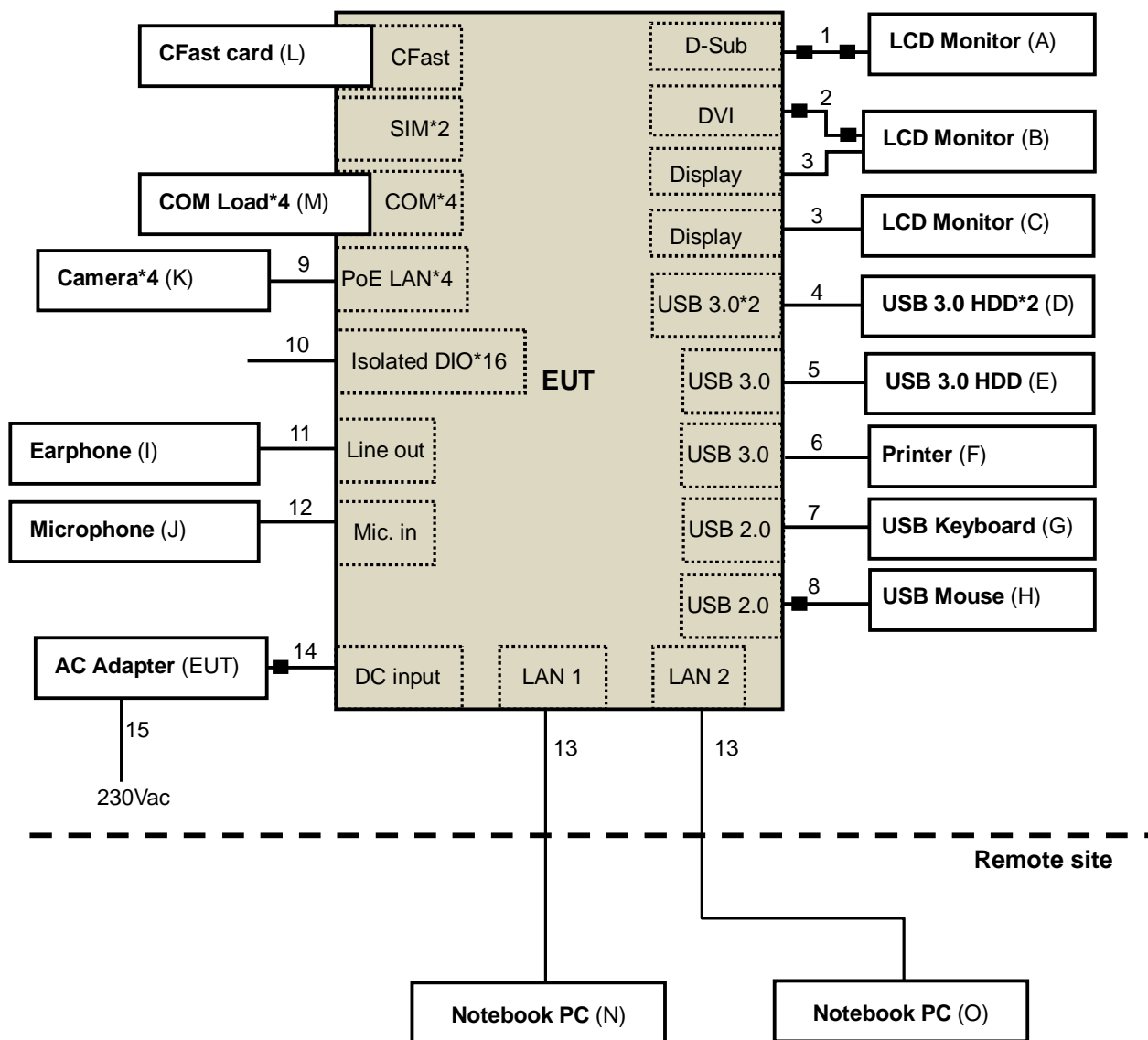

Harmonics, Flicker, Immunity tests:

TEST CONFIGURATION

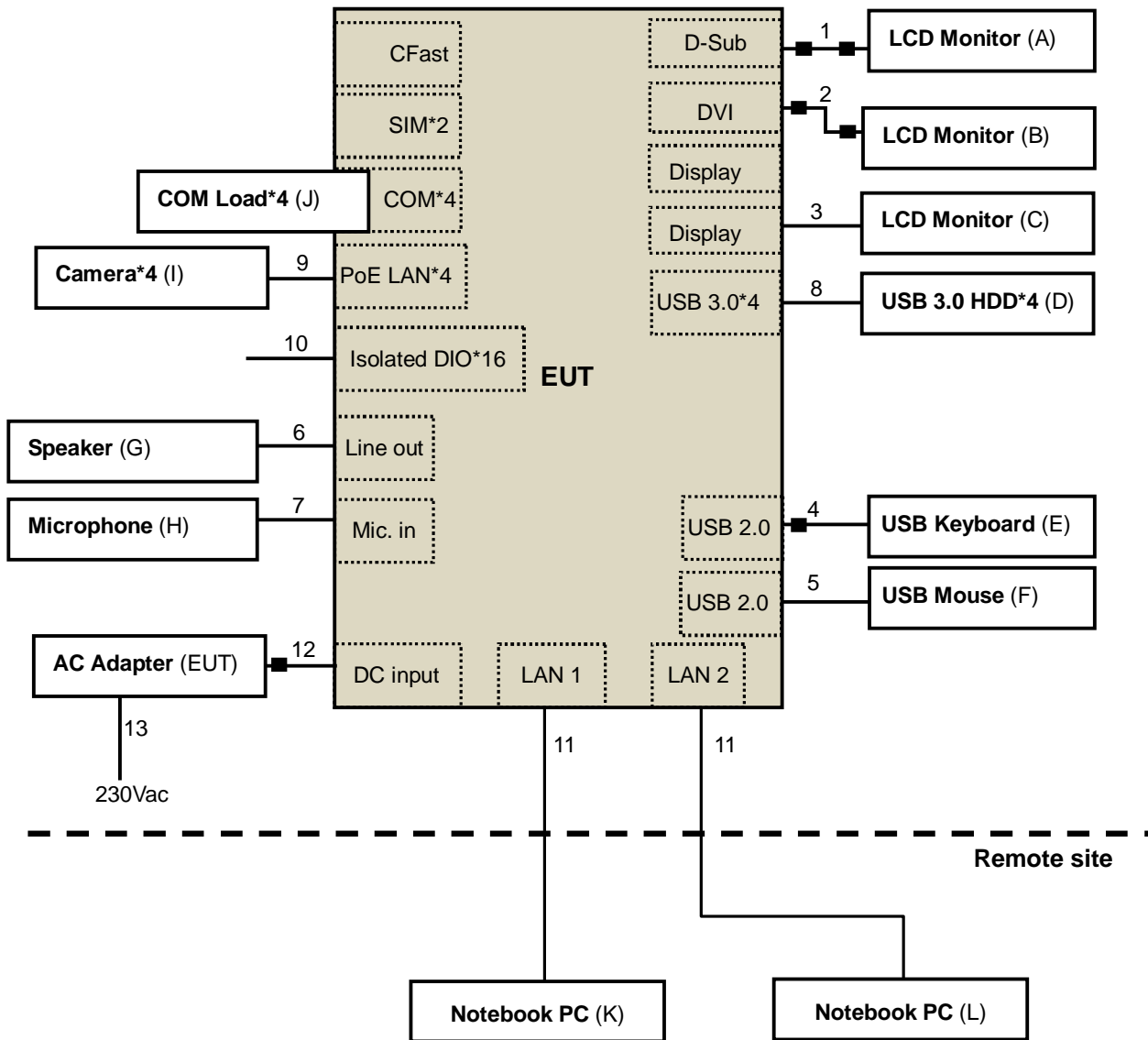

4.2 Configuration of Peripheral Devices and Cable Connections

Emission tests (Harmonics & Flicker excluded):

ID	Product	Brand	Model No.	Serial No.	FCC ID	Remarks
A.	24" LCD MONITOR	HP	LA2405wg	CN41210FHH	FCC DoC Approved	Provided by Lab
B.	28" LCD MONITOR	AOC	U2868PQU	HCXE8JA000362	FCC DoC Approved	Provided by Lab
C.	24" LCD MONITOR	DELL	UP2414Q	CN-0W009C2-74445-4 1L-034L	FCC DoC Approved	Provided by Lab
D.	USB 3.0 Hard Disk	WD	WDBACY5000ABL -PESN	WXA1A81U3670	FCC DoC Approved	Provided by Lab
	USB 3.0 Hard Disk	WD	WDBACY5000ABL -PESN	WX11E91JE773	FCC DoC Approved	Provided by Lab
E.	USB 3.0 Hard Disk	WD	WDBACY5000ABL -PESN	WXD1E91JMPR4	FCC DoC Approved	Provided by Lab
F.	PRINTER	LEXMARK	Z33	N/A	FCC DoC Approved	Provided by Lab
G.	USB KEYBOARD	BTC	5200U	G09302046625	E5XKB5122U	Provided by Lab
H.	USB Mouse	Microsoft	1113	9170515772204	FCC DOC Approved	Provided by Lab
I.	EARPHONE	PHILIPS	SBC HL145	N/A	N/A	Provided by Lab
J.	MICROPHONE	Labtec	mic-333	N/A	N/A	Provided by Lab
K.	3M Fixed Mini Indoor Dome Network Camera*4	3M	A301MIF-3N	T31504053	N/A	Supplied by client
		3M	A301MIF-3N	T31504054	N/A	Supplied by client
		3M	A301MIF-3N	T31504055	N/A	Supplied by client
		3M	A301MIF-3N	T31504056	N/A	Supplied by client
L.	CFast card	Memoright	MCFA J500	T032C21C390008	N/A	Supplied by client
M.	COM Load*4	N/A	N/A	N/A	N/A	Supplied by client
N.	Notebook PC	ASUS	PU401L	ECNXBC012528528	FCC DoC Approved	Provided by Lab
O.	Notebook PC	SONY	SVS151A12P	275548477001024	FCC DoC Approved	Provided by Lab

Note:

1. All power cords of the above support units are non-shielded (1.8m).
2. Items N-O acted as communication partners to transfer data.

ID	Descriptions	Qty.	Length (m)	Shielding (Yes/No)	Cores (Qty.)	Remarks
1.	D-Sub cable	1	1.8	Y	2	Provided by Lab
2.	DVI cable	1	1.8	Y	2	Provided by Lab
3.	Display cable	2	1.8	Y	0	Provided by Lab
4.	USB cable	2	0.4	Y	0	Provided by Lab
5.	USB cable	1	0.4	Y	0	Provided by Lab
6.	USB cable	1	1.5	Y	0	Provided by Lab
7.	USB cable	1	1.5	Y	0	Provided by Lab
8.	USB cable	1	1.8	Y	1	Provided by Lab
9.	LAN cable	4	1.2	Y	0	Supplied by client
10.	Data cable	16	0.4	N	0	Supplied by client
11.	Audio cable	1	1.2	N	0	Provided by Lab
12.	Audio cable	1	1.8	N	0	Provided by Lab
13.	LAN cable	2	10	N	0	Provided by Lab
14.	DC cable	1	1.0	N	1	Supplied by client
15.	AC power cord	1	1.8	N	0	Provided by Lab

Note: The core(s) is(are) originally attached to the cable(s).

Harmonics, Flicker, Immunity tests:

ID	Product	Brand	Model No.	Serial No.	FCC ID	Remarks
A.	WIDESCREEN FLAT PANEL MONITOR	DELL	2408WFP	CNONN79274261823S 1DMS	FCC DoC Approved	Provided by Lab
B.	WIDESCREEN FLAT PANEL MONITOR	DELL	2408WFP	CNOG293H742618742 68S	FCC DoC Approved	Provided by Lab
C.	24" LCD MONITOR	DELL	U2413f	CN-06VNX5-72872-46 D-A89L	FCC DoC Approved	Provided by Lab
D.	USB 3.0 Hard Disk	BUFFALO	HD-HXU3	15564800201033	FCC DoC Approved	Provided by Lab
	USB 3.0 Hard Disk	BUFFALO	HD-HX1	45564801002289	FCC DoC Approved	Provided by Lab
	USB 3.0 Hard Disk	BUFFALO	HD-HXU3	15564800200340	FCC DoC Approved	Provided by Lab
	USB 3.0 Hard Disk	BUFFALO	HD-HXU3	15564800201354	FCC DoC Approved	Provided by Lab
E.	USB KEYBOARD	DELL	SK-8115	CN-0J4635-71616-631- 076F	FCC DoC Approved	Provided by Lab
F.	USB MOUSE	HP	M-UAE96	F93A90AN3V42G07	FCC DoC Approved	Provided by Lab
G.	SPEAKER	KINYO	KSP-25	N/A	N/A	Provided by Lab
H.	MICROPHONE	Yinwei	YW-001	N/A	N/A	Provided by Lab
I.	3M Fixed Mini Indoor Dome Network Camera*4	3M	A301MIF-3N	T31504053	N/A	Supplied by client
		3M	A301MIF-3N	T31504054	N/A	Supplied by client
		3M	A301MIF-3N	T31504055	N/A	Supplied by client
		3M	A301MIF-3N	T31504056	N/A	Supplied by client
J.	COM Load*4	N/A	N/A	N/A	N/A	Supplied by client
K.	Notebook PC	DELL	Latitude E6520	2ZW55Q1	FCC DoC Approved	Provided by Lab
L.	Notebook PC	Lenovo	L440	R90FCKH8	FCC DoC Approved	Provided by Lab

Note:

1. All power cords of the above support units are non-shielded (1.8m).
2. Items K-L acted as communication partners to transfer data.

ID	Descriptions	Qty.	Length (m)	Shielding (Yes/No)	Cores (Qty.)	Remarks
1.	D-Sub cable	1	1.8	Y	2	Provided by Lab
2.	DVI cable	1	1.8	Y	2	Provided by Lab
3.	Display cable	1	1.8	Y	0	Provided by Lab
4.	USB cable	1	1.8	Y	1	Provided by Lab
5.	USB cable	1	1.8	Y	0	Provided by Lab
6.	Audio cable	1	1.0	N	0	Provided by Lab
7.	Audio cable	1	1.5	N	0	Provided by Lab
8.	USB cable	4	1.0	Y	0	Provided by Lab
9.	LAN cable	4	10	Y	0	Provided by Lab
10.	Data cable	16	0.4	N	0	Supplied by client
11.	LAN cable	2	10	N	0	Provided by Lab
12.	DC cable	1	1.0	N	1	Supplied by client
13.	AC power cord	1	1.8	N	0	Provided by Lab

Note: The core(s) is(are) originally attached to the cable(s).

5 Conducted Disturbance at Mains Ports

5.1 Limits

Frequency (MHz)	Class A (dBuV)		Class B (dBuV)	
	Quasi-peak	Average	Quasi-peak	Average
0.15 - 0.5	79	66	66 - 56	56 - 46
0.50 - 5.0	73	60	56	46
5.0 - 30.0	73	60	60	50

Notes: 1. The lower limit shall apply at the transition frequencies.
2. The limit decreases linearly with the logarithm of the frequency in the range of 0.15 to 0.50 MHz.

5.2 Test Instruments

Description & Manufacturer	Model No.	Serial No.	Cal. Date	Cal. Due
ROHDE & SCHWARZ TEST RECEIVER	ESCS 30	838251/021	Oct. 26, 2015	Oct. 25, 2016
ROHDE & SCHWARZ Artificial Mains Network (For EUT)	ENV216	101195	Apr. 27, 2015	Apr. 26, 2016
LISN With Adapter (for EUT)	AD10	C03Ada-002	Apr. 27, 2015	Apr. 26, 2016
EMCO L.I.S.N. (For peripherals)	3825/2	9504-2359	Jul. 27, 2015	Jul. 26, 2016
SCHWARZBECK Artificial Mains Network (For EUT)	NNLK8129	8129229	May 06, 2015	May 05, 2016
Software	Cond_V7.3.7	NA	NA	NA
RF cable (JYEBAO) With 10dB PAD	5D-FB	Cable-C03.01	Sep. 23, 2015	Sep. 22, 2016
LYNICS Terminator (For EMCO LISN)	0900510	E1-01-300	Jan. 20, 2016	Jan. 19, 2017
LYNICS Terminator (For EMCO LISN)	0900510	E1-01-301	Jan. 20, 2016	Jan. 19, 2017
ROHDE & SCHWARZ Artificial Mains Network (For TV EUT)	ESH3-Z5	100220	Nov. 13, 2015	Nov. 12, 2016
LISN With Adapter (for TV EUT)	100220	N/A	Nov. 13, 2015	Nov. 12, 2016

Notes: 1. The calibration interval of the above test instruments is 12 months and the calibrations are traceable to NML/ROC and NIST/USA.
2. The test was performed in Shielded Room No. 3.
3. The VCCI Site Registration No. C-274.
4. Tested Date: Feb. 17, 2016.

5.3 Test Arrangement

- The EUT was placed 0.4 meters from the conducting wall of the shielded room with EUT being connected to the power mains through a line impedance stabilization network (LISN). Other support units were connected to the power mains through another LISN. The two LISNs provide 50 Ohm/ 50uH of coupling impedance for the measuring instrument.
- Both lines of the power mains connected to the EUT were checked for maximum conducted interference.
- The test results of conducted emissions at mains ports are recorded of six worst margins for quasi-peak (mandatory) [and average (if necessary)] values against the limits at frequencies of interest unless the margin is 20 dB or greater.

Note: The resolution bandwidth and video bandwidth of test receiver is 9kHz for quasi-peak detection (QP) and average detection (AV) at frequency 0.15MHz-30MHz.

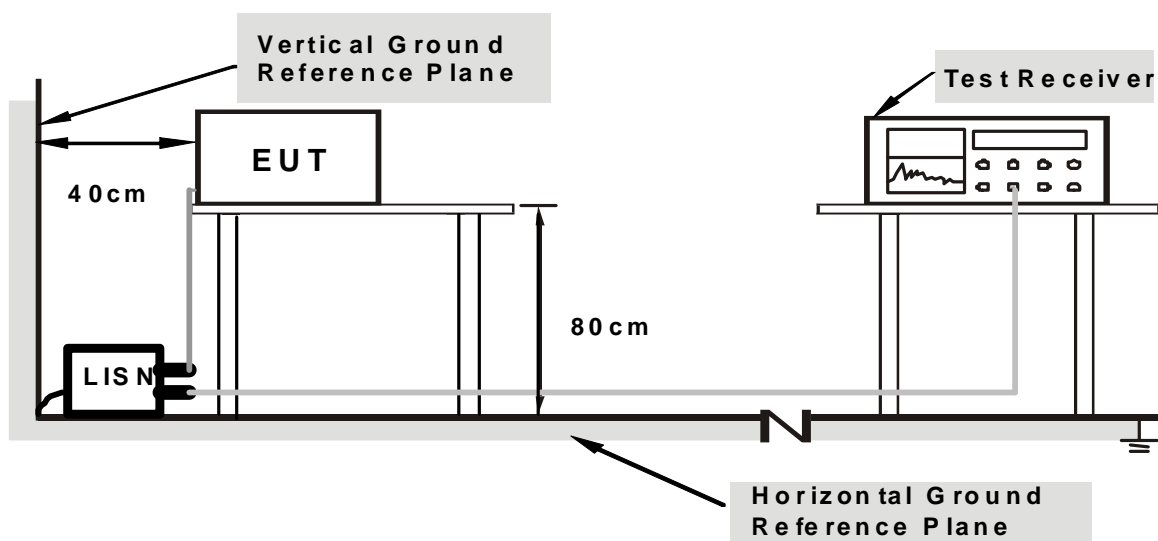

Note: Support units were connected to second LISN.

For the actual test configuration, please refer to the related item – Photographs of the Test Configuration.

5.4 Test Results

Frequency Range	150kHz ~ 30MHz	Detector Function & Bandwidth	Quasi-Peak (QP) / Average (AV), 9kHz
Input Power	230Vac, 50Hz	Environmental Conditions	18°C, 72%RH
Tested by	T.H. Tseng		
Test Mode	Mode 1		

Phase Of Power : Line (L)										
No	Frequency (MHz)	Correction Factor (dB)	Reading Value (dBuV)		Emission Level (dBuV)		Limit (dBuV)		Margin (dB)	
			Q.P.	AV.	Q.P.	AV.	Q.P.	AV.	Q.P.	AV.
1	0.15781	9.69	46.42	38.37	56.11	48.06	79.00	66.00	-22.89	-17.94
2	2.46218	9.73	34.32	33.52	44.05	43.25	73.00	60.00	-28.95	-16.75
3	2.90695	9.74	39.30	38.76	49.04	48.50	73.00	60.00	-23.96	-11.50
4	3.13784	9.74	35.29	34.65	45.03	44.39	73.00	60.00	-27.97	-15.61
5	3.35579	9.74	34.41	33.87	44.15	43.61	73.00	60.00	-28.85	-16.39
6	7.38389	9.80	37.80	37.27	47.60	47.07	73.00	60.00	-25.40	-12.93

Remarks:

1. Q.P. and AV. are abbreviations of quasi-peak and average individually.
2. The emission levels of other frequencies were very low against the limit.
3. Margin value = Emission level – Limit value
4. Correction factor = Insertion loss + Cable loss
5. Emission Level = Correction Factor + Reading Value

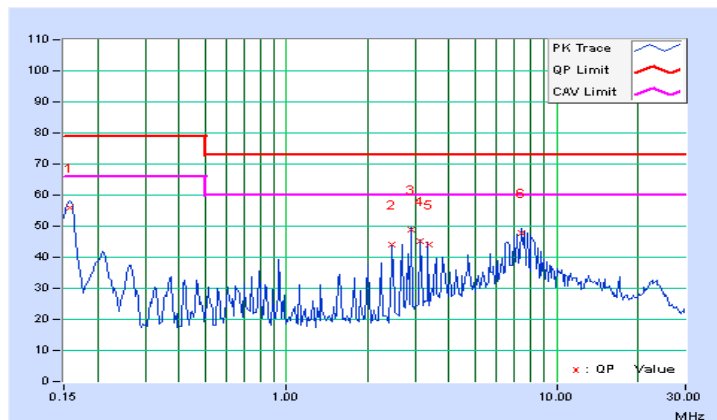

Frequency Range	150kHz ~ 30MHz	Detector Function & Bandwidth	Quasi-Peak (QP) / Average (AV), 9kHz
Input Power	230Vac, 50Hz	Environmental Conditions	18°C, 72%RH
Tested by	T.H. Tseng		
Test Mode	Mode 1		

Phase Of Power : Neutral (N)										
No	Frequency (MHz)	Correction Factor (dB)	Reading Value (dBuV)		Emission Level (dBuV)		Limit (dBuV)		Margin (dB)	
			Q.P.	AV.	Q.P.	AV.	Q.P.	AV.	Q.P.	AV.
1	0.15781	9.65	45.85	39.39	55.50	49.04	79.00	66.00	-23.50	-16.96
2	2.47642	9.70	34.71	34.03	44.41	43.73	73.00	60.00	-28.59	-16.27
3	2.92485	9.71	38.88	38.46	48.59	48.17	73.00	60.00	-24.41	-11.83
4	3.37999	9.71	32.39	32.32	42.10	42.03	73.00	60.00	-30.90	-17.97
5	7.43124	9.77	37.94	36.95	47.71	46.72	73.00	60.00	-25.29	-13.28
6	7.88615	9.78	35.95	35.10	45.73	44.88	73.00	60.00	-27.27	-15.12

Remarks:

1. Q.P. and AV. are abbreviations of quasi-peak and average individually.
2. The emission levels of other frequencies were very low against the limit.
3. Margin value = Emission level – Limit value
4. Correction factor = Insertion loss + Cable loss
5. Emission Level = Correction Factor + Reading Value

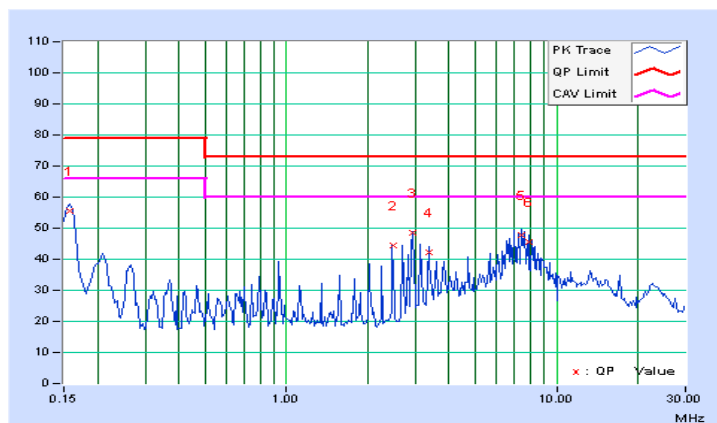

6 Conducted Disturbance at Telecommunication Ports

6.1 Limits

For Class A Equipment

Frequency (MHz)	Voltage Limit (dBuV)		Current limits (dBuA)	
	Quasi-peak	Average	Quasi-peak	Average
0.15-0.5	97-87	84-74	53-43	40-30
0.5-30	87	74	43	30

Note: The limits decrease linearly with the logarithm of the frequency in the range 0.15 MHz to 0.5 MHz.

For Class B Equipment

Frequency (MHz)	Voltage Limit (dBuV)		Current limits (dBuA)	
	Quasi-peak	Average	Quasi-peak	Average
0.15-0.5	84-74	74-64	40-30	30-20
0.5-30	74	64	30	20

Note: The limits decrease linearly with the logarithm of the frequency in the range 0.15 MHz to 0.5 MHz.

6.2 Test Instruments

Description & Manufacturer	Model No.	Serial No.	Cal. Date	Cal. Due
ROHDE & SCHWARZ TEST RECEIVER	ESCS 30	838251/021	Oct. 26, 2015	Oct. 25, 2016
ROHDE & SCHWARZ Artificial Mains Network (For EUT)	ENV216	101195	Apr. 27, 2015	Apr. 26, 2016
LISN With Adapter (for EUT)	AD10	C03Ada-002	Apr. 27, 2015	Apr. 26, 2016
EMCO L.I.S.N. (For peripherals)	3825/2	9504-2359	Jul. 27, 2015	Jul. 26, 2016
Software	Cond_V7.3.7	NA	NA	NA
Software	ISN_V7.3.7	NA	NA	NA
RF cable (JYEBAO)	5D-FB	Cable-C03.01	Sep. 23, 2015	Sep. 22, 2016
LYNICS Terminator (For EMCO LISN)	0900510	E1-01-300	Jan. 20, 2016	Jan. 19, 2017
LYNICS Terminator (For EMCO LISN)	0900510	E1-01-301	Jan. 20, 2016	Jan. 19, 2017
FCC ISN	F-071115-1057-1	20652	Jan. 12, 2016	Jan. 11, 2017
TESEQ ISN	ISN ST08	41212	Aug. 12, 2015	Aug. 11, 2016

- Notes:
1. The calibration interval of the above test instruments is 12 months and the calibrations are traceable to NML/ROC and NIST/USA.
 2. The test was performed in Shielded Room No. 3.
 3. The VCCI Site Registration No. T-1651.
 4. Tested Date: Feb. 17 ~ 23, 2016.

6.3 Test Arrangement

Method of Annex C.1.1, Using ISNs:

- a. The EUT is placed 0.4 meters from the conducting wall of the shielded room and connected to ISN directly to reference ground plane.
- b. If voltage measurement is used, measure voltage at the measurement port of the ISN, correct the reading by adding the ISN voltage division factor, and compare to the voltage limit.
- c. If current measurement is used, measure current with the current probe and compare to the current limit. A 50 Ω load has to be connected to the measurement port of the ISN during the current measurement.
- d. It is not necessary to apply the voltage and the current limit if a ISN is used.
- e. The test results of disturbance at telecommunication ports are recorded of six worst margins for quasi-peak (mandatory) [and average (if necessary)] values against the limits at frequencies of interest unless the margin is 20 dB or greater.

Note: The resolution bandwidth and video bandwidth of test receiver is 9kHz for quasi-peak detection (QP) and average detection (AV) at frequency 0.15MHz-30MHz.

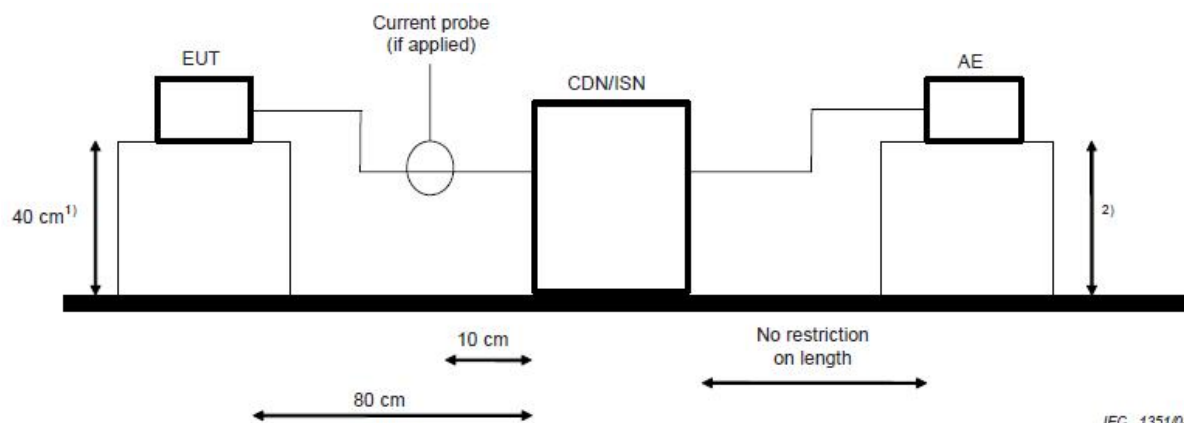

IEC 1351/08

AE = Associated equipment
EUT = Equipment under test

- 1) Distance to the reference groundplane (vertical or horizontal).
- 2) Distance to the reference groundplane is not critical.

6.4 Supplementary Information

The condition of LAN utilization in excess of 10 % and sustaining that level for a minimum of 250 ms is created by command TFGEN+PING.

6.5 Test Results

Frequency Range	150kHz ~ 30MHz	Detector Function & Bandwidth	Quasi-Peak (QP) / Average (AV), 9kHz
Input Power	230Vac, 50Hz	Environmental Conditions	18°C, 72%RH
Tested by	T.H. Tseng		
Test Mode	Mode 1 RJ45 TELECOM PORT 1 (10Mbps)		

No	Frequency (MHz)	Correction Factor (dB)	Reading Value (dBuV)		Emission Level (dBuV)		Limit (dBuV)		Margin (dB)	
			Q.P.	AV.	Q.P.	AV.	Q.P.	AV.	Q.P.	AV.
1	0.94044	9.25	46.90	46.20	56.15	55.45	87.00	74.00	-30.85	-18.55
2	2.47804	9.16	41.57	40.69	50.73	49.85	87.00	74.00	-36.27	-24.15
3	2.92578	9.15	46.76	46.46	55.91	55.61	87.00	74.00	-31.09	-18.39
4	3.37882	9.14	43.39	42.14	52.53	51.28	87.00	74.00	-34.47	-22.72
5	7.43468	9.14	45.70	43.96	54.84	53.10	87.00	74.00	-32.16	-20.90
6	10.00000	9.17	64.22	51.61	73.39	60.78	87.00	74.00	-13.61	-13.22

Remarks:

1. Q.P. and AV. are abbreviations of quasi-peak and average individually.
2. The emission levels of other frequencies were very low against the limit.
3. Margin value = Emission level – Limit value
4. Correction factor = Insertion loss + Cable loss
5. Emission Level = Correction Factor + Reading Value

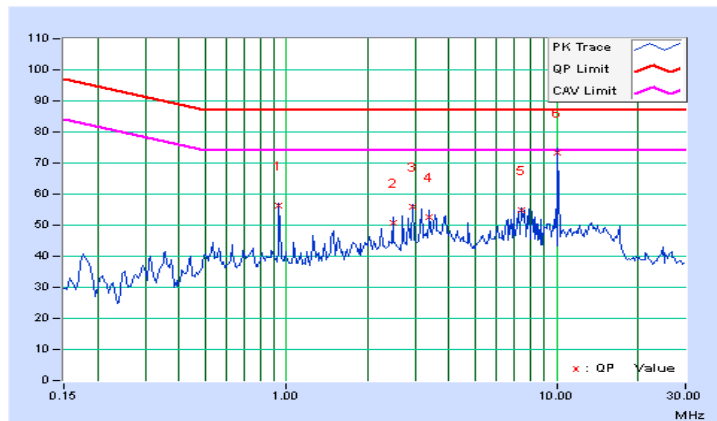

Frequency Range	150kHz ~ 30MHz	Detector Function & Bandwidth	Quasi-Peak (QP) / Average (AV), 9kHz
Input Power	230Vac, 50Hz	Environmental Conditions	18°C, 72%RH
Tested by	T.H. Tseng		
Test Mode	Mode 1 RJ45 TELECOM PORT 1 (100Mbps)		

No	Frequency (MHz)	Correction Factor (dB)	Reading Value (dBuV)		Emission Level (dBuV)		Limit (dBuV)		Margin (dB)	
			Q.P.	AV.	Q.P.	AV.	Q.P.	AV.	Q.P.	AV.
1	0.94297	9.25	47.29	46.73	56.54	55.98	87.00	74.00	-30.46	-18.02
2	3.13281	9.14	44.11	43.38	53.25	52.52	87.00	74.00	-33.75	-21.48
3	7.53906	9.14	43.23	41.31	52.37	50.45	87.00	74.00	-34.63	-23.55
4	17.76953	9.33	40.54	24.25	49.87	33.58	87.00	74.00	-37.13	-40.42
5	21.66406	9.42	41.28	28.95	50.70	38.37	87.00	74.00	-36.30	-35.63
6	25.46484	9.53	39.74	20.35	49.27	29.88	87.00	74.00	-37.73	-44.12

Remarks:

1. Q.P. and AV. are abbreviations of quasi-peak and average individually.
2. The emission levels of other frequencies were very low against the limit.
3. Margin value = Emission level – Limit value
4. Correction factor = Insertion loss + Cable loss
5. Emission Level = Correction Factor + Reading Value

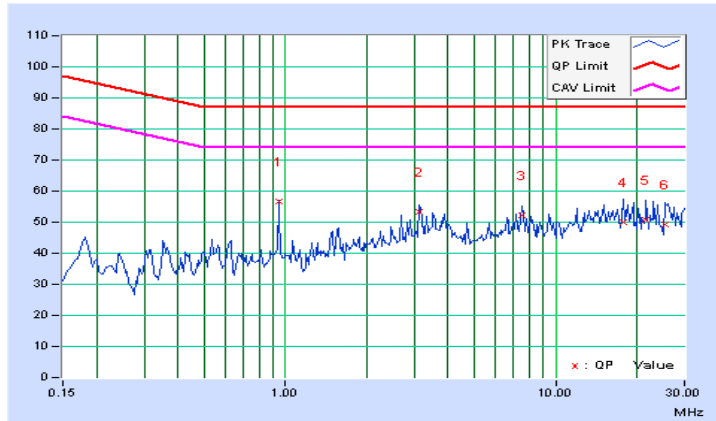

Frequency Range	150kHz ~ 30MHz	Detector Function & Bandwidth	Quasi-Peak (QP) / Average (AV), 9kHz
Input Power	230Vac, 50Hz	Environmental Conditions	18°C, 72%RH
Tested by	T.H. Tseng		
Test Mode	Mode 1 RJ45 TELECOM PORT 1 (1Gbps)		

No	Frequency (MHz)	Correction Factor (dB)	Reading Value (dBuV)		Emission Level (dBuV)		Limit (dBuV)		Margin (dB)	
			Q.P.	AV.	Q.P.	AV.	Q.P.	AV.	Q.P.	AV.
1	0.94050	9.25	46.74	45.90	55.99	55.15	87.00	74.00	-31.01	-18.85
2	2.49006	9.16	41.87	41.11	51.03	50.27	87.00	74.00	-35.97	-23.73
3	2.94325	9.15	47.43	47.18	56.58	56.33	87.00	74.00	-30.42	-17.67
4	3.39835	9.14	42.78	41.20	51.92	50.34	87.00	74.00	-35.08	-23.66
5	7.47111	9.14	45.93	45.14	55.07	54.28	87.00	74.00	-31.93	-19.72
6	7.92941	9.15	44.06	43.20	53.21	52.35	87.00	74.00	-33.79	-21.65

Remarks:

1. Q.P. and AV. are abbreviations of quasi-peak and average individually.
2. The emission levels of other frequencies were very low against the limit.
3. Margin value = Emission level – Limit value
4. Correction factor = Insertion loss + Cable loss
5. Emission Level = Correction Factor + Reading Value

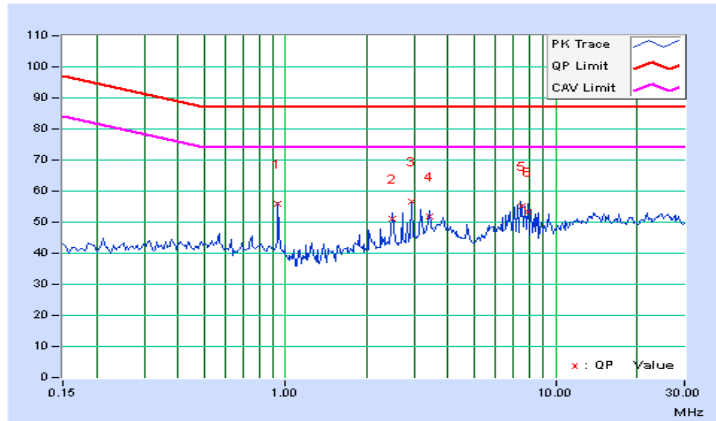

Frequency Range	150kHz ~ 30MHz	Detector Function & Bandwidth	Quasi-Peak (QP) / Average (AV), 9kHz
Input Power	230Vac, 50Hz	Environmental Conditions	18°C, 72%RH
Tested by	T.H. Tseng		
Test Mode	Mode 2 RJ45 TELECOM PORT 2 (10Mbps)		

No	Frequency (MHz)	Correction Factor (dB)	Reading Value (dBuV)		Emission Level (dBuV)		Limit (dBuV)		Margin (dB)	
			Q.P.	AV.	Q.P.	AV.	Q.P.	AV.	Q.P.	AV.
1	0.94034	9.25	47.41	46.70	56.66	55.95	87.00	74.00	-30.34	-18.05
2	2.91797	9.15	44.26	43.87	53.41	53.02	87.00	74.00	-33.59	-20.98
3	3.37101	9.14	41.46	40.41	50.60	49.55	87.00	74.00	-36.40	-24.45
4	7.41311	9.14	41.92	41.39	51.06	50.53	87.00	74.00	-35.94	-23.47
5	10.00000	9.17	58.72	34.49	67.89	43.66	87.00	74.00	-19.11	-30.34
6	13.69531	9.24	36.70	32.05	45.94	41.29	87.00	74.00	-41.06	-32.71

Remarks:

1. Q.P. and AV. are abbreviations of quasi-peak and average individually.
2. The emission levels of other frequencies were very low against the limit.
3. Margin value = Emission level – Limit value
4. Correction factor = Insertion loss + Cable loss
5. Emission Level = Correction Factor + Reading Value

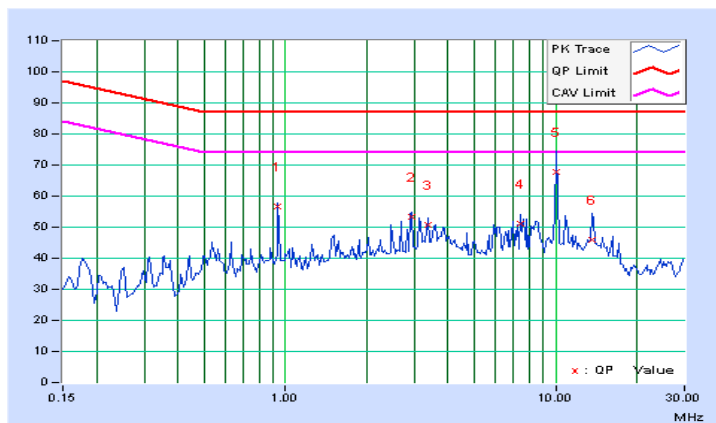

Frequency Range	150kHz ~ 30MHz	Detector Function & Bandwidth	Quasi-Peak (QP) / Average (AV), 9kHz
Input Power	230Vac, 50Hz	Environmental Conditions	18°C, 72%RH
Tested by	T.H. Tseng		
Test Mode	Mode 2 RJ45 TELECOM PORT 2 (100Mbps)		

No	Frequency (MHz)	Correction Factor (dB)	Reading Value (dBuV)		Emission Level (dBuV)		Limit (dBuV)		Margin (dB)	
			Q.P.	AV.	Q.P.	AV.	Q.P.	AV.	Q.P.	AV.
1	0.94034	9.25	48.45	46.74	57.70	55.99	87.00	74.00	-29.30	-18.01
2	2.90642	9.15	44.87	44.74	54.02	53.89	87.00	74.00	-32.98	-20.11
3	7.38590	9.14	41.85	41.19	50.99	50.33	87.00	74.00	-36.01	-23.67
4	13.35938	9.24	45.29	42.40	54.53	51.64	87.00	74.00	-32.47	-22.36
5	18.24219	9.34	47.71	45.33	57.05	54.67	87.00	74.00	-29.95	-19.33
6	23.12891	9.46	48.28	46.14	57.74	55.60	87.00	74.00	-29.26	-18.40

Remarks:

1. Q.P. and AV. are abbreviations of quasi-peak and average individually.
2. The emission levels of other frequencies were very low against the limit.
3. Margin value = Emission level – Limit value
4. Correction factor = Insertion loss + Cable loss
5. Emission Level = Correction Factor + Reading Value

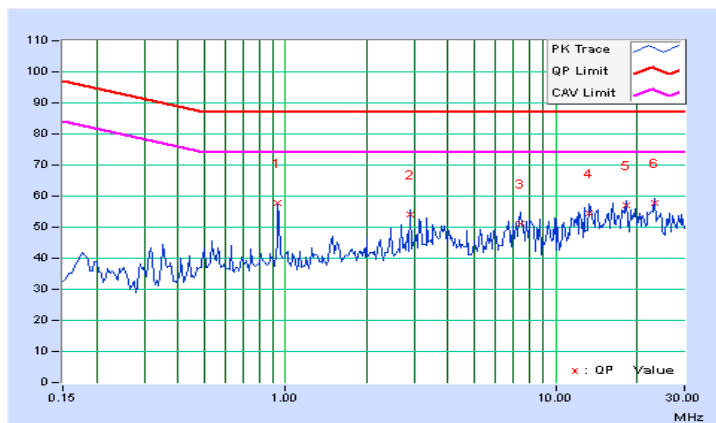

Frequency Range	150kHz ~ 30MHz	Detector Function & Bandwidth	Quasi-Peak (QP) / Average (AV), 9kHz
Input Power	230Vac, 50Hz	Environmental Conditions	18°C, 72%RH
Tested by	T.H. Tseng		
Test Mode	Mode 2 RJ45 TELECOM PORT 2 (1Gbps)		

No	Frequency (MHz)	Correction Factor (dB)	Reading Value (dBuV)		Emission Level (dBuV)		Limit (dBuV)		Margin (dB)	
			Q.P.	AV.	Q.P.	AV.	Q.P.	AV.	Q.P.	AV.
1	0.94034	9.25	47.41	46.57	56.66	55.82	87.00	74.00	-30.34	-18.18
2	2.94922	9.15	43.82	43.61	52.97	52.76	87.00	74.00	-34.03	-21.24
3	3.17578	9.14	42.19	39.27	51.33	48.41	87.00	74.00	-35.67	-25.59
4	3.40616	9.14	40.34	38.87	49.48	48.01	87.00	74.00	-37.52	-25.99
5	7.03684	9.14	41.83	40.69	50.97	49.83	87.00	74.00	-36.03	-24.17
6	7.49087	9.14	42.01	40.90	51.15	50.04	87.00	74.00	-35.85	-23.96

Remarks:

1. Q.P. and AV. are abbreviations of quasi-peak and average individually.
2. The emission levels of other frequencies were very low against the limit.
3. Margin value = Emission level – Limit value
4. Correction factor = Insertion loss + Cable loss
5. Emission Level = Correction Factor + Reading Value

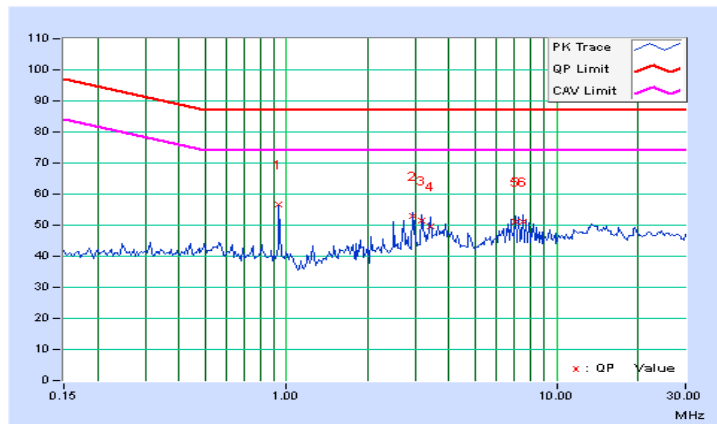

Frequency Range	150kHz ~ 30MHz	Detector Function & Bandwidth	Quasi-Peak (QP) / Average (AV), 9kHz
Input Power	230Vac, 50Hz	Environmental Conditions	18°C, 72%RH
Tested by	T.H. Tseng		
Test Mode	Mode 3 PoE LAN 4		

No	Frequency (MHz)	Correction Factor (dB)	Reading Value (dBuV)		Emission Level (dBuV)		Limit (dBuV)		Margin (dB)	
			Q.P.	AV.	Q.P.	AV.	Q.P.	AV.	Q.P.	AV.
1	0.56016	9.61	45.96	44.51	55.57	54.12	87.00	74.00	-31.43	-19.88
2	0.74766	9.61	46.55	45.19	56.16	54.80	87.00	74.00	-30.84	-19.20
3	0.93516	9.60	49.26	47.57	58.86	57.17	87.00	74.00	-28.14	-16.83
4	1.12109	9.60	53.45	53.01	63.05	62.61	87.00	74.00	-23.95	-11.39
5	1.26563	9.60	50.78	49.99	60.38	59.59	87.00	74.00	-26.62	-14.41
6	3.12500	9.63	45.81	45.80	55.44	55.43	87.00	74.00	-31.56	-18.57

Remarks:

1. Q.P. and AV. are abbreviations of quasi-peak and average individually.
2. The emission levels of other frequencies were very low against the limit.
3. Margin value = Emission level – Limit value
4. Correction factor = Insertion loss + Cable loss
5. Emission Level = Correction Factor + Reading Value

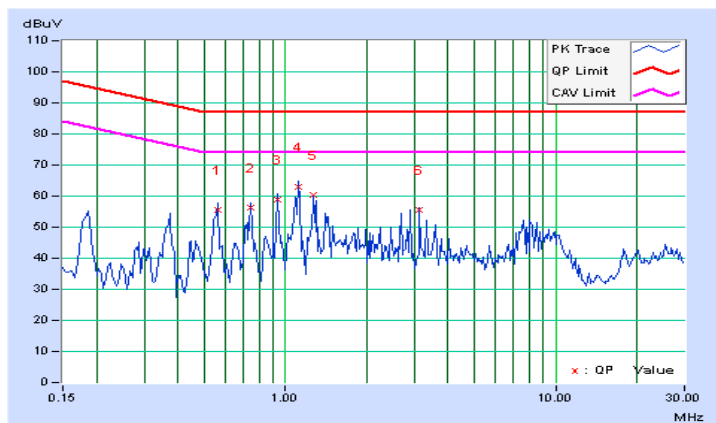

Frequency Range	150kHz ~ 30MHz	Detector Function & Bandwidth	Quasi-Peak (QP) / Average (AV), 9kHz
Input Power	230Vac, 50Hz	Environmental Conditions	18°C, 72%RH
Tested by	T.H. Tseng		
Test Mode	Mode 4 PoE LAN 6		

No	Frequency (MHz)	Correction Factor (dB)	Reading Value (dBuV)		Emission Level (dBuV)		Limit (dBuV)		Margin (dB)	
			Q.P.	AV.	Q.P.	AV.	Q.P.	AV.	Q.P.	AV.
1	0.74766	9.61	44.26	42.45	53.87	52.06	87.00	74.00	-33.13	-21.94
2	0.93516	9.60	47.48	45.12	57.08	54.72	87.00	74.00	-29.92	-19.28
3	1.11981	9.60	51.73	51.00	61.33	60.60	87.00	74.00	-25.67	-13.40
4	1.24609	9.60	45.40	44.13	55.00	53.73	87.00	74.00	-32.00	-20.27
5	3.12891	9.63	45.27	45.26	54.90	54.89	87.00	74.00	-32.10	-19.11
6	7.82031	9.83	39.36	36.24	49.19	46.07	87.00	74.00	-37.81	-27.93

Remarks:

1. Q.P. and AV. are abbreviations of quasi-peak and average individually.
2. The emission levels of other frequencies were very low against the limit.
3. Margin value = Emission level – Limit value
4. Correction factor = Insertion loss + Cable loss
5. Emission Level = Correction Factor + Reading Value

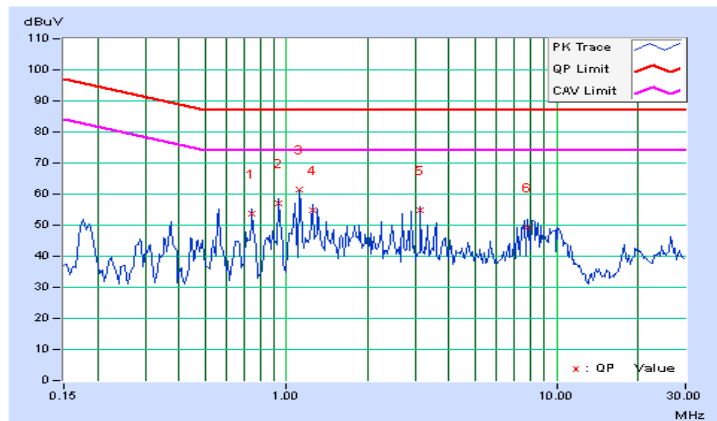

7 Radiated Disturbance up to 1 GHz

7.1 Limits

Frequency (MHz)	Class A (at 10m)	Class B (at 10m)
	dBuV/m	dBuV/m
30 - 230	40	30
230 - 1000	47	37

- Notes:
1. The lower limit shall apply at the transition frequencies.
 2. Emission level (dBuV/m) = 20 log Emission level (uV/m).
 3. All emanations from a class A/B digital device or system, including any network of conductors and apparatus connected thereto, shall not exceed the level of field strengths specified above.

7.2 Test Instruments

Description & Manufacturer	Model No.	Serial No.	Cal. Date	Cal. Due
ROHDE & SCHWARZ TEST RECEIVER	ESCS 30	845552/004	Sep. 03, 2015	Sep. 02, 2016
Schaffner Bilog Antenna	CBL6111D	22262	Jan. 07, 2016	Jan. 06, 2017
ADT. Turn Table	TT100	0205	NA	NA
ADT. Tower	AT100	0205	NA	NA
Software	Radiated_V7.6.15.9.4	NA	NA	NA
ADT RF Switches BOX	EMH-011	1001	Feb. 15, 2016	Feb. 14, 2017
Pacific RF cable With 5dB PAD	8D	CABLE-ST2-01	Feb. 15, 2016	Feb. 14, 2017

- Notes:
1. The calibration interval of the above test instruments is 12 months and the calibrations are traceable to NML/ROC and NIST/USA.
 2. The test was performed in Open Site No. 2.
 3. The VCCI Site Registration No. R-237.
 4. The FCC Site Registration No. 90424.
 5. Tested Date: Feb. 22, 2016.

7.3 Test Arrangement

- The EUT was placed on the top of a rotating table 0.8 meters above the ground at an accredited test facility. The table was rotated 360 degrees to determine the position of the highest radiation.
- The EUT was set 10 meters away from the interference-receiving antenna, which was mounted on the top of a variable-height antenna tower.
- The antenna is a broadband antenna, and its height is varied from one meter to four meters above the ground to determine the maximum value of the field strength. Both horizontal and vertical polarizations of the antenna are set to make the measurement.
- For each suspected emission, the EUT was arranged to its worst case and then the antenna was tuned to heights from 1 meter to 4 meters and the rotatable table was turned from 0 degrees to 360 degrees to find the maximum reading.
- The test-receiver system was set to quasi-peak detect function and specified bandwidth with maximum hold mode when the test frequency is up to 1 GHz.

Note: The resolution bandwidth and video bandwidth of test receiver/spectrum analyzer is 120kHz for quasi-peak detection (QP) at frequency up to 1GHz.

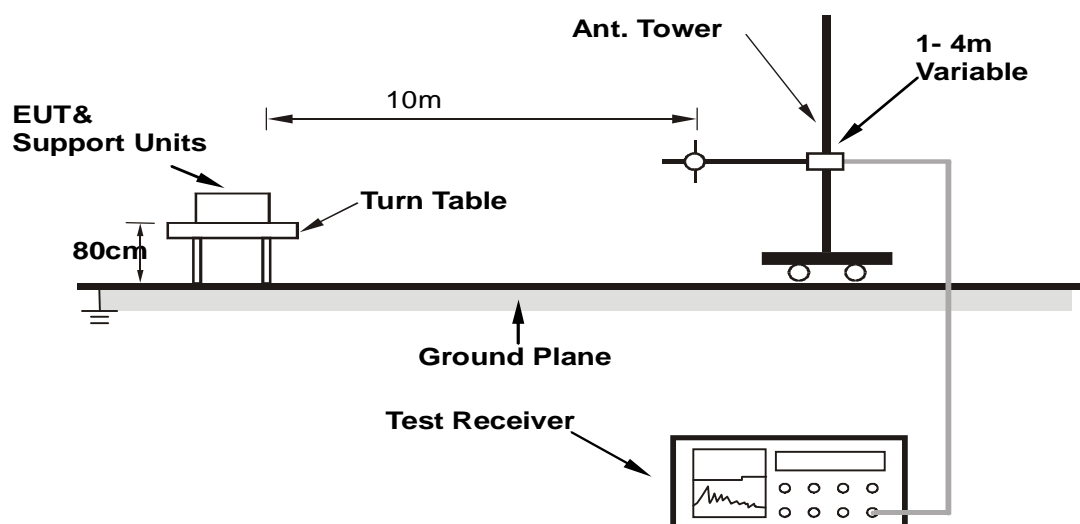

For the actual test configuration, please refer to the related item – Photographs of the Test Configuration.

7.4 Test Results

Frequency Range	30MHz ~ 1GHz	Detector Function & Bandwidth	Quasi-Peak (QP), 120kHz
Tested by	Vincent Lin	Environmental Conditions	26°C, 76%RH
Test Mode	Mode 1		

Antenna Polarity & Test Distance : Horizontal at 10 m

No	Frequency (MHz)	Emission Level (dBuV/m)	Limit (dBuV/m)	Margin (dB)	Antenna Height (m)	Table Angle (Degree)	Raw Value (dBuV)	Correction Factor (dB/m)
1	35.22	26.79 QP	40.00	-13.21	4.00 H	84	4.90	21.89
2	66.01	32.52 QP	40.00	-7.48	4.00 H	64	20.18	12.34
3	82.50	33.41 QP	40.00	-6.59	4.00 H	112	19.43	13.98
4	113.48	32.76 QP	40.00	-7.24	4.00 H	208	15.26	17.50
5	125.01	29.68 QP	40.00	-10.32	4.00 H	143	11.50	18.18
6	153.41	33.24 QP	40.00	-6.76	4.00 H	217	15.60	17.65
7	214.55	30.28 QP	40.00	-9.72	4.00 H	134	14.36	15.92
8	299.75	30.81 QP	47.00	-16.19	4.00 H	215	10.17	20.64
9	352.85	31.04 QP	47.00	-15.96	3.71 H	4	9.02	22.02
10	445.52	33.32 QP	47.00	-13.68	2.23 H	176	8.56	24.76
11	594.05	41.13 QP	47.00	-5.87	2.38 H	37	13.06	28.08
12	651.25	39.32 QP	47.00	-7.68	1.00 H	76	10.61	28.71
13	742.57	40.94 QP	47.00	-6.06	1.72 H	155	9.88	31.06
14	891.08	40.25 QP	47.00	-6.75	1.10 H	109	7.77	32.48
15	1000.00	40.01 QP	47.00	-6.99	1.02 H	199	5.70	34.31

Remarks:

1. Emission Level(dBuV/m) = Raw Value(dBuV) + Correction Factor(dB/m)
2. Correction Factor(dB/m) = Antenna Factor (dB/m) + Cable Factor (dB) – Pre-Amplifier Factor (dB)
3. The other emission levels were very low against the limit.
4. Margin value = Emission level – Limit value

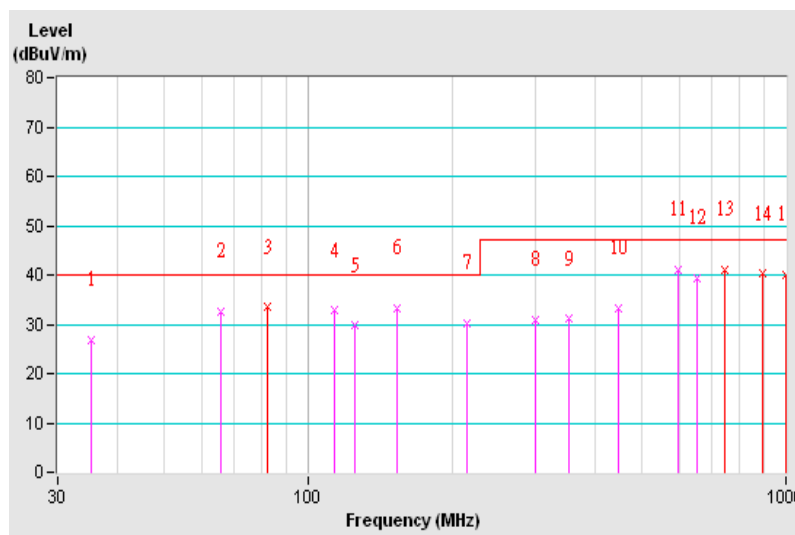

Frequency Range	30MHz ~ 1GHz	Detector Function & Bandwidth	Quasi-Peak (QP), 120kHz
Tested by	Vincent Lin	Environmental Conditions	26°C, 76%RH
Test Mode	Mode 1		

Antenna Polarity & Test Distance : Vertical at 10 m								
No	Frequency (MHz)	Emission Level (dBuV/m)	Limit (dBuV/m)	Margin (dB)	Antenna Height (m)	Table Angle (Degree)	Raw Value (dBuV)	Correction Factor (dB/m)
1	53.05	28.93 QP	40.00	-11.07	1.00 V	229	15.92	13.01
2	66.00	32.76 QP	40.00	-7.24	1.00 V	50	20.42	12.34
3	82.50	35.80 QP	40.00	-4.20	1.61 V	359	21.82	13.98
4	125.01	32.83 QP	40.00	-7.17	1.00 V	273	14.65	18.18
5	146.43	33.70 QP	40.00	-6.30	1.00 V	139	15.63	18.07
6	154.84	29.26 QP	40.00	-10.74	1.00 V	100	11.63	17.63
7	263.57	37.25 QP	47.00	-9.75	1.00 V	352	17.10	20.15
8	299.96	38.13 QP	47.00	-8.87	1.28 V	61	17.49	20.64
9	400.01	35.99 QP	47.00	-11.01	1.91 V	199	12.25	23.74
10	445.55	31.85 QP	47.00	-15.15	1.79 V	266	7.08	24.76
11	594.16	41.78 QP	47.00	-5.22	2.50 V	6	13.69	28.08
12	630.94	37.30 QP	47.00	-9.70	3.09 V	88	8.31	28.99
13	700.01	39.09 QP	47.00	-7.91	2.25 V	78	9.88	29.21
14	742.57	40.46 QP	47.00	-6.54	2.65 V	225	9.40	31.06
15	891.07	41.03 QP	47.00	-5.97	2.34 V	331	8.55	32.48
16	999.99	40.23 QP	47.00	-6.77	2.84 V	175	5.92	34.31

Remarks:

1. Emission Level(dBuV/m) = Raw Value(dBuV) + Correction Factor(dB/m)
2. Correction Factor(dB/m) = Antenna Factor (dB/m) + Cable Factor (dB) – Pre-Amplifier Factor (dB)
3. The other emission levels were very low against the limit.
4. Margin value = Emission level – Limit value

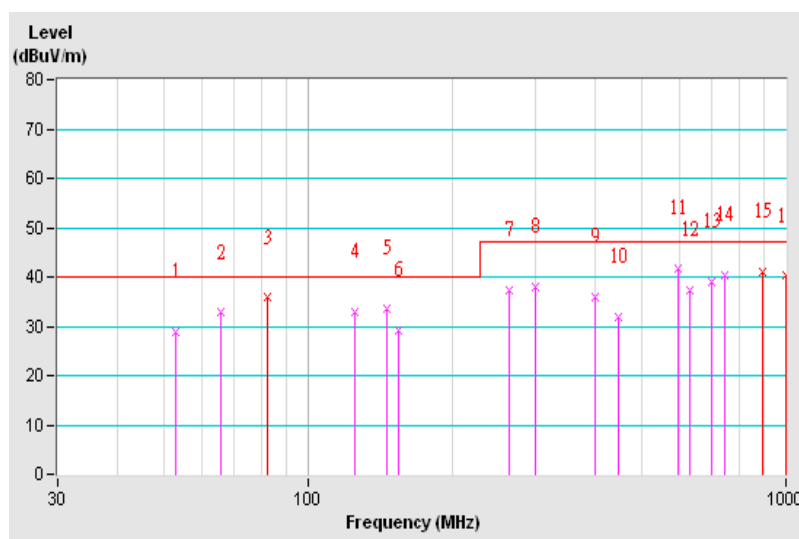

8 Radiated Disturbance above 1 GHz

8.1 Limits

Frequency (GHz)	Class A (dBuV/m) (at 3m)		Class B (dBuV/m) (at 3m)	
	Average	Peak	Average	Peak
1 to 3	56	76	50	70
3 to 6	60	80	54	74

- Notes: 1. The lower limit shall apply at the transition frequencies.
 2. Emission level (dBuV/m) = 20 log Emission level (uV/m).
 3. All emanations from a class A/B digital device or system, including any network of conductors and apparatus connected thereto, shall not exceed the level of field strengths specified above.

Frequency Range (For unintentional radiators)

Highest frequency generated or used in the EUT or on which the EUT operates or tunes (MHz)	Upper frequency of measurement range (MHz)
Below 108	1000
108-500	2000
500-1000	5000
Above 1000	Up to 5 times of the highest frequency or 6 GHz, whichever is less

8.2 Test Instruments

Description & Manufacturer	Model No.	Serial No.	Cal. Date	Cal. Due
Agilent Spectrum	E4446A	MY51100009	May 30, 2015	May 29, 2016
Agilent Test Receiver	N9038A	MY51210137	Jul. 13, 2015	Jul. 12, 2016
Agilent Preamplifier	8449B	3008A01292	Feb. 26, 2016	Feb. 25, 2017
MITEQ Preamplifier	AMF-6F-260400-33-8P	892164	Mar. 01, 2015	Feb. 28, 2016
EMCI Preamplifier	EMC184045B	980235	Mar. 01, 2015	Feb. 28, 2016
Schwarzbeck Horn Antenna	BBHA-9170	212	Jan. 08, 2016	Jan. 07, 2017
EMCO Horn Antenna	3115	6714	Jan. 19, 2016	Jan. 18, 2017
Max Full. Turn Table	MF7802	MF780208216	NA	NA
Software	Radiated_V8.7.07	NA	NA	NA
SUHNER RF cable With 4dB PAD	SF106-18	Cable-CH10	Aug. 15, 2015	Aug. 14, 2016
SUHNER RF cable With 3dB PAD	SF102	Cable-CH8-3.6m	Aug. 15, 2015	Aug. 14, 2016

- Notes: 1. The calibration interval of the above test instruments is 12 months and the calibrations are traceable to NML/ROC and NIST/USA.
 2. The 3dB beamwidth of the horn antenna is minimum 30 degree (or w = 1.6m at 3m distance) for 1~6 GHz.
 3. The test was performed in Chamber No. 10.
 4. The Industry Canada Reference No. IC 7450E-11.
 5. The VCCI Site Registration No. G-427
 6. The FCC Site Registration No. 367016
 7. Tested Date: Feb. 26, 2016.

8.3 Test Arrangement

- The EUT was placed on the top of a rotating table 0.8 meters above the ground at an accredited chamber room. The table was rotated 360 degrees to determine the position of the highest radiation.
- The EUT was set 3 meters away from the interference-receiving antenna, which was mounted on the top of a variable-height antenna tower.
- The height of antenna can be varied from one meter to four meters, the height of adjustment depends on the EUT height and the antenna 3dB beamwidth both, to detect the maximum value of the field strength. Both horizontal and vertical polarizations of the antenna are set to make the measurement.
- For each suspected emission, the EUT was arranged to its worst case and then the antenna was tuned to heights and the rotatable table was turned from 0 degrees to 360 degrees to find the maximum reading.
- The spectrum analyzer system was set to peak and average detect function and specified bandwidth with maximum hold mode when the test frequency is above 1 GHz.

Note: The resolution bandwidth of test receiver/spectrum analyzer is 1MHz and video bandwidth is 3MHz for Peak detection (PK) at frequency above 1GHz. The resolution bandwidth of test receiver/spectrum analyzer is 1 MHz for Average detection (AV) at frequency above 1GHz.

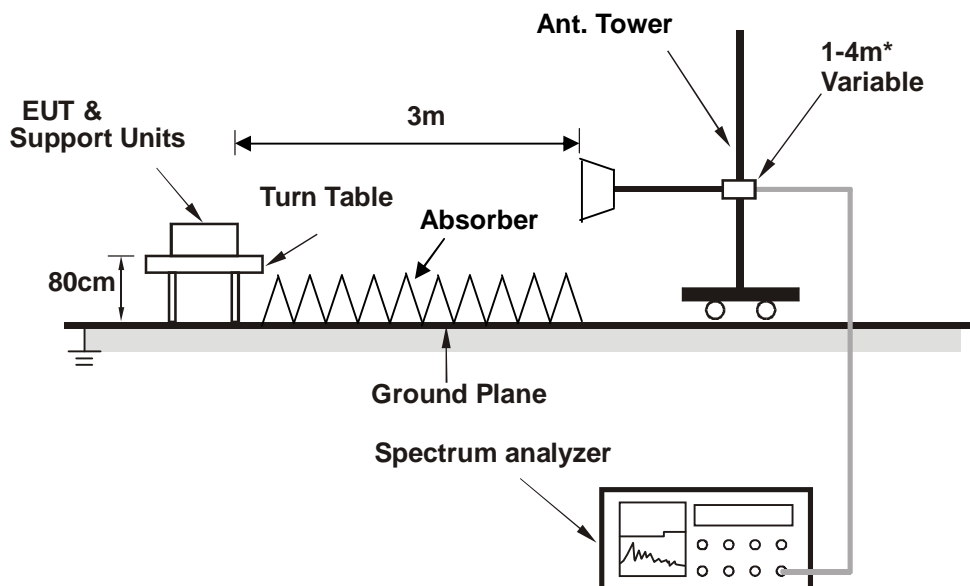

* :depends on the EUT height and the antenna 3dB beamwidth both.

For the actual test configuration, please refer to the related item – Photographs of the Test Configuration.

8.4 Test Results

Frequency Range	1GHz ~ 6GHz	Detector Function & Bandwidth	Peak (PK) / Average (AV), 1MHz
Tested by	Kobe Lu	Environmental Conditions	15°C, 74%RH
Test Mode	Mode 1		

Antenna Polarity & Test Distance : Horizontal at 3 m								
No	Frequency (MHz)	Emission Level (dBuV/m)	Limit (dBuV/m)	Margin (dB)	Antenna Height (m)	Table Angle (Degree)	Raw Value (dBuV)	Correction Factor (dB/m)
1	1035.93	58.85 PK	76.00	-17.15	1.54 H	259	63.98	-5.13
2	1035.93	36.08 AV	56.00	-19.92	1.54 H	259	41.21	-5.13
3	2079.20	55.55 PK	76.00	-20.45	2.00 H	227	56.90	-1.35
4	2079.20	43.71 AV	56.00	-12.29	2.00 H	227	45.06	-1.35
5	2227.77	56.12 PK	76.00	-19.88	1.00 H	190	57.11	-0.99
6	2227.77	45.50 AV	56.00	-10.50	1.00 H	190	46.49	-0.99
7	2699.86	53.44 PK	76.00	-22.56	2.42 H	162	52.70	0.74
8	2699.86	36.61 AV	56.00	-19.39	2.43 H	162	35.87	0.74
9	2984.98	58.82 PK	76.00	-17.18	2.30 H	247	57.08	1.74
10	2984.98	37.76 AV	56.00	-18.24	2.30 H	247	36.02	1.74

Remarks:

1. Emission Level(dBuV/m) = Raw Value(dBuV) + Correction Factor(dB/m)
2. Correction Factor(dB/m) = Antenna Factor (dB/m) + Cable Factor (dB) – Pre-Amplifier Factor (dB)
3. The other emission levels were very low against the limit.
4. Margin value = Emission level – Limit value

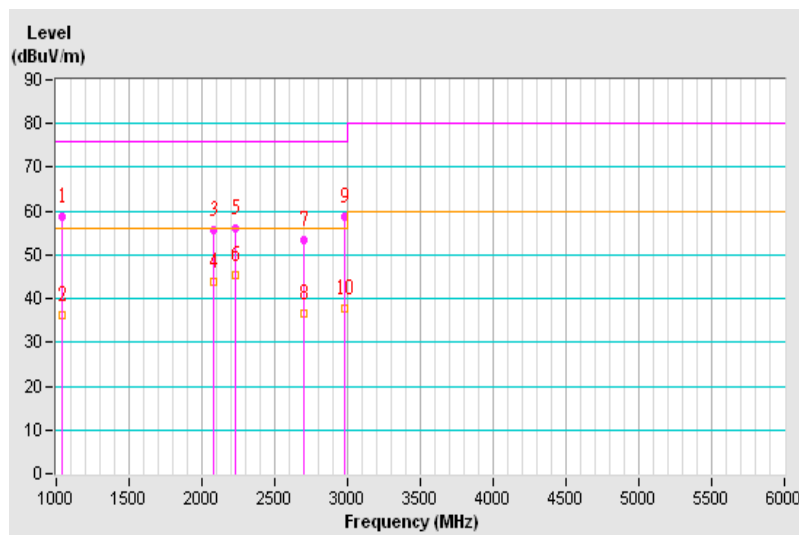

Frequency Range	1GHz ~ 6GHz	Detector Function & Bandwidth	Peak (PK) / Average (AV), 1MHz
Tested by	Kobe Lu	Environmental Conditions	15°C, 74%RH
Test Mode	Mode 1		

Antenna Polarity & Test Distance : Vertical at 3 m								
No	Frequency (MHz)	Emission Level (dBuV/m)	Limit (dBuV/m)	Margin (dB)	Antenna Height (m)	Table Angle (Degree)	Raw Value (dBuV)	Correction Factor (dB/m)
1	2079.17	59.27 PK	76.00	-16.73	1.05 V	356	60.62	-1.35
2	2079.17	47.85 AV	56.00	-8.15	1.05 V	356	49.20	-1.35
3	2227.80	58.32 PK	76.00	-17.68	2.50 V	359	59.31	-0.99
4	2227.80	48.99 AV	56.00	-7.01	2.50 V	359	49.98	-0.99
5	2689.63	56.23 PK	76.00	-19.77	1.98 V	187	55.54	0.69
6	2689.63	38.08 AV	56.00	-17.92	1.98 V	187	37.39	0.69
7	2955.64	58.01 PK	76.00	-17.99	1.97 V	234	56.36	1.65
8	2955.64	37.37 AV	56.00	-18.63	1.97 V	234	35.72	1.65

Remarks:

1. Emission Level(dBuV/m) = Raw Value(dBuV) + Correction Factor(dB/m)
2. Correction Factor(dB/m) = Antenna Factor (dB/m) + Cable Factor (dB) – Pre-Amplifier Factor (dB)
3. The other emission levels were very low against the limit.
4. Margin value = Emission level – Limit value

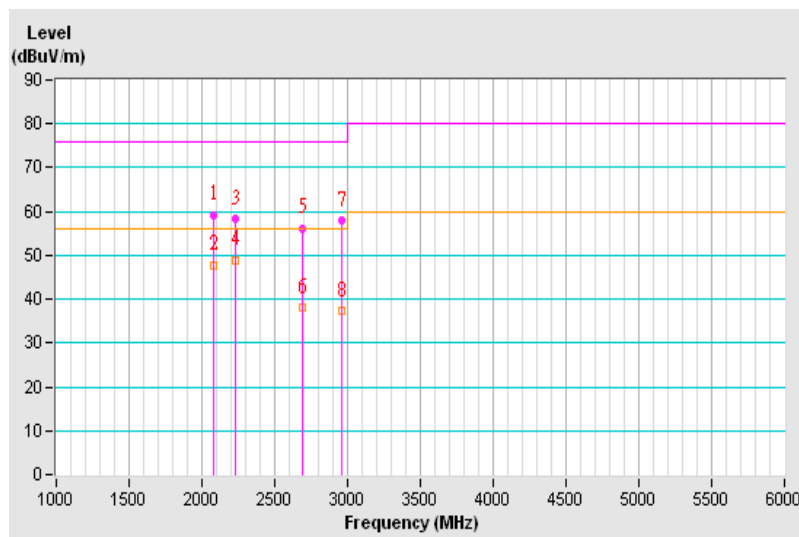

9 Harmonics Current Measurement

9.1 Limits

Limits for Class A equipment		Limits for Class D equipment		
Harmonic Order n	Max. permissible harmonics current A	Harmonic Order n	Max. permissible harmonics current per watt mA/W	Max. permissible harmonics current A
Odd harmonics		Odd Harmonics only		
3	2.30	3	3.4	2.30
5	1.14	5	1.9	1.14
7	0.77	7	1.0	0.77
9	0.40	9	0.5	0.40
11	0.33	11	0.35	0.33
13	0.21	13	0.30	0.21
15 ≤ n ≤ 39	0.15 x 15/n	15 ≤ n ≤ 39	3.85/n	0.15 x 15/n
Even harmonics				
2	1.08			
4	0.43			
6	0.30			
8 ≤ n ≤ 40	0.23 x 8/n			

Notes: 1. Class A and Class D are classified according to section 5 of EN 61000-3-2.

2. According to section 7 of EN 61000-3-2, the above limits for all equipment except for lighting equipment having an active input power > 75 W and no limits apply for equipment with an active input power up to and including 75 W.

9.2 Classification of Equipment

Class A	Class B	Class C	Class D
Balanced three-phase equipment; Household appliances excluding equipment as Class D; Tools excluding portable tools; Dimmers for incandescent lamps; Audio equipment; Equipment not specified in one of the three other classes.	Portable tools; Arc welding equipment which is not professional equipment.	Lighting equipment.	Equipment having a specified power less than or equal to 600 W of the following types: Personal computers and personal computer monitors; Television receivers; Refrigerators and freezers having one or more variable-speed drives to control compressor motor(s).

9.3 Test Instruments

Description & Manufacturer	Model No.	Serial No.	Cal. Date	Cal. Due
EMC PARTNER EMC Emission Tester	HAR1000-1P	084	Apr. 24, 2015	Apr. 23, 2016
Software	HARCS	NA	NA	NA

Notes: 1. The calibration interval of the above test instruments is 12 months and the calibrations are traceable to NML/ROC and NIST/USA.

2. The test was performed in EMS Room No. 1.

3. According to IEC 61000-4-7: 2002, the time window shall be synchronized with each group of 10 or 12 cycles (200 ms) for power frequency of 50 or 60Hz.

4. Tested Date: Mar. 3, 2016.

9.4 Test Arrangement

- a. The EUT was placed on the top of a wooden table 0.8 meters above the ground and operated to produce the maximum harmonic components under normal operating conditions for each successive harmonic component in turn.
- b. The correspondent test program of test instrument to measure the current harmonics emanated from EUT is chosen. The measure time shall be not less than the time necessary for the EUT to be exercised.

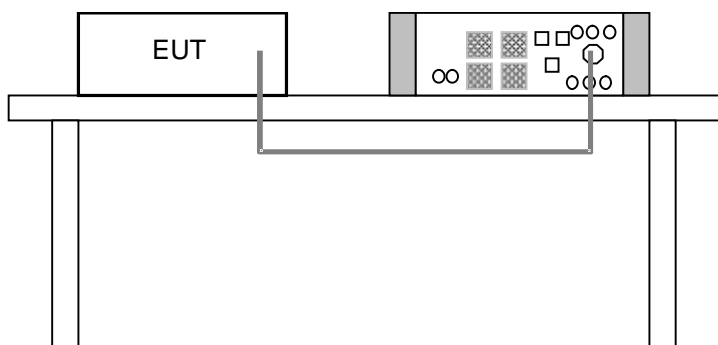

For the actual test configuration, please refer to the related item – Photographs of the Test Configuration.

9.5 Test Results

Fundamental Voltage/Ampere	229.5Vrms/ 0.323Arms	Power Frequency	50.000Hz
Power Consumption	59.88W	Power Factor	0.808
Environmental Conditions	27 °C, 58%RH	Tested by	Aga Lin
Test Mode	Mode 1		

- Note: 1. Limits are not specified for equipment with a rated power of 75W or less (other than lighting equipment).
2. According to EN 61000-3-2 the manufacturer shall specify the power of the apparatus. This value shall be used for establishing limits. The specified power shall be within +/-10% of the measured power.

10 Voltage Fluctuations and Flicker Measurement

10.1 Limits

Test item	Limit	Note
P_{st}	1.0	P_{st} : short-term flicker severity.
P_{lt}	0.65	P_{lt} : long-term flicker severity.
T_{max} (ms)	500	T_{max} : maximum time duration during the observation period that the voltage deviation $d(t)$ exceeds the limit for d_c .
d_{max} (%)	4	d_{max} : maximum absolute voltage change during an observation period.
d_c (%)	3.3	d_c : maximum steady state voltage change during an observation period.

10.2 Test Instruments

Description & Manufacturer	Model No.	Serial No.	Cal. Date	Cal. Due
EMC PARTNER EMC Emission Tester	HAR1000-1P	084	Apr. 24, 2015	Apr. 23, 2016
Software	HARCS	NA	NA	NA

- Notes:
- The calibration interval of the above test instruments is 12 months and the calibrations are traceable to NML/ROC and NIST/USA.
 - The test was performed in EMS Room No. 1.
 - Tested Date: Mar. 3, 2016.

10.3 Test Arrangement

- The EUT was placed on the top of a wooden table 0.8 meters above the ground and operated to produce the most unfavorable sequence of voltage changes under normal operating conditions.
- During the flick measurement, the measure time shall include that part of whole operation cycle in which the EUT produce the most unfavorable sequence of voltage changes. The observation period for short-term flicker indicator is 10 minutes and the observation period for long-term flicker indicator is 2 hours.

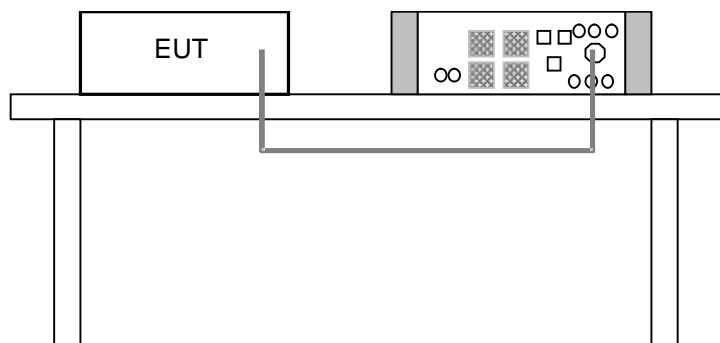

For the actual test configuration, please refer to the related item – Photographs of the Test Configuration.

10.4 Test Results

Observation (T _p)	120 minutes	Power Frequency	50.000 Hz
Fundamental Voltage/Ampere	229.5 Vrms / 0.323 Arms	Power Factor	0.808
Environmental Conditions	27 °C, 58 % RH	Long-Term Flicker Indicator (Plt)	0.072
Test Mode	Mode 1	Tested by	Aga Lin

Test Parameter	Pst	dmax (%)	dc (%)	Td(t) (ms)	Remarks
1	0.072	0.000	0.010	0.000	Pass
2	0.072	0.000	0.010	0.000	Pass
3	0.072	0.000	0.010	0.000	Pass
4	0.072	0.000	0.010	0.000	Pass
5	0.072	0.000	0.010	0.000	Pass
6	0.072	0.000	0.010	0.000	Pass
7	0.072	0.000	0.010	0.000	Pass
8	0.072	0.000	0.010	0.000	Pass
9	0.072	0.000	0.010	0.000	Pass
10	0.072	0.000	0.010	0.000	Pass
11	0.072	0.000	0.010	0.000	Pass
12	0.072	0.000	0.010	0.000	Pass

- Note:
1. Pst means short-term flicker indicator.
 2. Tdt means maximum time that dt exceeds 3.3 %.
 3. dmax means maximum relative voltage change.
 4. dc means relative steady-state voltage change.

11 General Immunity Requirements

EN 55024:2010, Immunity requirements

Clause	Reference standard	Table	Test specification	Performance Criterion
4.2.1	EN/IEC 61000-4-2 ESD	1.3	Enclosure port: ±8kV Air discharge, ±4kV Contact discharge	B
4.2.3.2	EN/IEC 61000-4-3 RS	1.2	Enclosure port: 80-1000 MHz, 3V/m, 80% AM (1kHz)	A
4.2.2	EN/IEC 61000-4-4 EFT	2.3	Signal ports and telecommunication ports: xDSL equipment: ±0.5kV, 5/50 (T _r /T _h) ns, 100kHz others: ±0.5kV, 5/50 (T _r /T _h) ns, 5kHz	B
		3.3	Input DC power port: ±0.5kV, 5/50 (T _r /T _h) ns, 5kHz	
		4.5	Input AC Power ports: ±1kV, 5/50 (T _r /T _h) ns, 5kHz	
4.2.5	EN/IEC 61000-4-5 Surge	2.2	Signal and telecommunication ports (direct to outdoor cables): 10/700 (5/320) (T _r /T _h) μs w/o primary protectors: ±1kV, or with primary protectors fitted: ±4kV	C
		3.2	Input DC power port (direct to outdoor cables): 1.2/50 (8/20) (T _r /T _h) μs Line to earth: ±0.5kV	
		4.4	Input AC Power ports: 1.2/50 (8/20) (T _r /T _h) μs, Line to line: ±1kV Line to earth: ±2kV	
4.2.3.3	EN/IEC 61000-4-6 CS	2.1	Signal and telecommunication ports(cable length > 3m): 0.15-80 MHz, 3V, 80% AM (1kHz)	A
		3.1	Input DC power port: 0.15-80 MHz, 3V, 80% AM (1kHz)	
		4.1	Input AC Power ports: 0.15-80 MHz, 3V, 80% AM (1kHz)	
4.2.4	EN/IEC 61000-4-8 PFMF	1.1	Enclosure port: 50 or 60 Hz, 1A/m	A
4.2.6	EN/IEC 61000-4-11 Dips & Interruptions	4.2	Input AC Power ports: Voltage Dips: >95% reduction – 0.5 period 30% reduction – 25 periods	B C
		4.3	Input AC Power ports: Voltage Interruptions: >95% reduction – 250 periods	C

11.1 Performance Criteria

General Performance Criteria

Performance criterion A

The equipment shall continue to operate as intended without operator intervention. No degradation of performance or loss of function is allowed below a performance level specified by the manufacturer when the equipment is used as intended. The performance level may be replaced by a permissible loss of performance. If the minimum performance level or the permissible performance loss is not specified by the manufacturer, then either of these may be derived from the product description and documentation, and by what the user may reasonably expect from the equipment if used as intended.

Performance criterion B

After the test, the equipment shall continue to operate as intended without operator intervention. No degradation of performance or loss of function is allowed, after the application of the phenomena below a performance level specified by the manufacturer, when the equipment is used as intended. The performance level may be replaced by a permissible loss of performance. During the test, degradation of performance is allowed. However, no change of operating state or stored data is allowed to persist after the test. If the minimum performance level (or the permissible performance loss) is not specified by the manufacturer, then either of these may be derived from the product description and documentation, and by what the user may reasonably expect from the equipment if used as intended.

Performance criterion C

Loss of function is allowed, provided the function is self-recoverable, or can be restored by the operation of the controls by the user in accordance with the manufacturer's instructions. Functions, and/or information stored in non-volatile memory, or protected by a battery backup, shall not be lost.

Particular performance criteria

The particular performance criteria which are specified in the normative annexes of EN 55024 take precedence over the corresponding parts of the general performance criteria. Where particular performance criteria for specific functions are not given, then the general performance criteria shall apply.

12 Electrostatic Discharge Immunity Test (ESD)

12.1 Test Specification

Basic Standard:	EN/IEC 61000-4-2
Discharge Impedance:	330 ohm / 150 pF
Discharge Voltage:	Air Discharge: $\pm 2\text{kV}$, $\pm 4\text{kV}$, $\pm 8\text{kV}$ (Direct) Contact Discharge: $\pm 2\text{kV}$, $\pm 4\text{kV}$ (Direct/Indirect)
Number of Discharge:	Air – Direct: 10 discharges per location (each polarity) Contact – Direct & Indirect: 25 discharges per location (each polarity) and min. 200 times in total
Discharge Mode:	Single Discharge
Discharge Period:	1-second minimum

12.2 Test Instruments

Description & Manufacturer	Model No.	Serial No.	Cal. Date	Cal. Due
KeyTek, ESD Simulator	MZ-15/EC	0504259	Oct. 26, 2015	Oct. 25, 2016

- Notes:
1. The calibration interval of the above test instruments is 12 months and the calibrations are traceable to NML/ROC and NIST/USA.
 2. The test was performed in ESD Room No. 1.
 3. Tested Date: Mar. 16, 2016.

12.3 Test Arrangement

The discharges shall be applied in two ways:

- a. Contact discharges to the conductive surfaces and coupling planes:

The EUT shall be exposed to at least 200 discharges, 100 each at negative and positive polarity, at a minimum of four test points. One of the test points shall be subjected to at least 50 indirect discharges to the center of the front edge of the horizontal coupling plane. The remaining three test points shall each receive at least 50 direct contact discharges. If no direct contact test points are available, then at least 200 indirect discharges shall be applied in the indirect mode. Test shall be performed at a maximum repetition rate of one discharge per second.

- b. Air discharges at slots and apertures and insulating surfaces:

On those parts of the EUT where it is not possible to perform contact discharge testing, the equipment should be investigated to identify user accessible points where breakdown may occur. Such points are tested using the air discharge method. This investigation should be restricted to those area normally handled by the user. A minimum of 10 single air discharges shall be applied to the selected test point for each such area.

The basic test procedure was in accordance with EN/IEC 61000-4-2:

- a. Electrostatic discharges were applied only to those points and surfaces of the EUT that are accessible to users during normal operation.
- b. The test was performed with at least ten single discharges on the pre-selected points in the most sensitive polarity.
- c. The time interval between two successive single discharges was at least 1 second.
- d. The ESD generator was held perpendicularly to the surface to which the discharge was applied and the return cable was at least 0.2 meters from the EUT.
- e. Contact discharges were applied to the non-insulating coating, with the pointed tip of the generator penetrating the coating and contacting the conducting substrate.
- f. Air discharges were applied with the round discharge tip of the discharge electrode approaching the EUT as fast as possible (without causing mechanical damage) to touch the EUT. After each discharge, the ESD generator was removed from the EUT and re-triggered for a new single discharge. The test was repeated until all discharges were complete.
- g. At least ten single discharges (in the most sensitive polarity) were applied to the **Horizontal Coupling Plane** at points on each side of the EUT. The ESD generator was positioned at a distance of 0.1 meters from the EUT with the discharge electrode touching the **HCP**.
- h. At least ten single discharges (in the most sensitive polarity) were applied to the center of one vertical edge of the **Vertical Coupling Plane** in sufficiently different positions that the four faces of the EUT were completely illuminated. The **VCP** (dimensions 0.5m x 0.5m) was placed vertically to and 0.1 meters from the EUT.

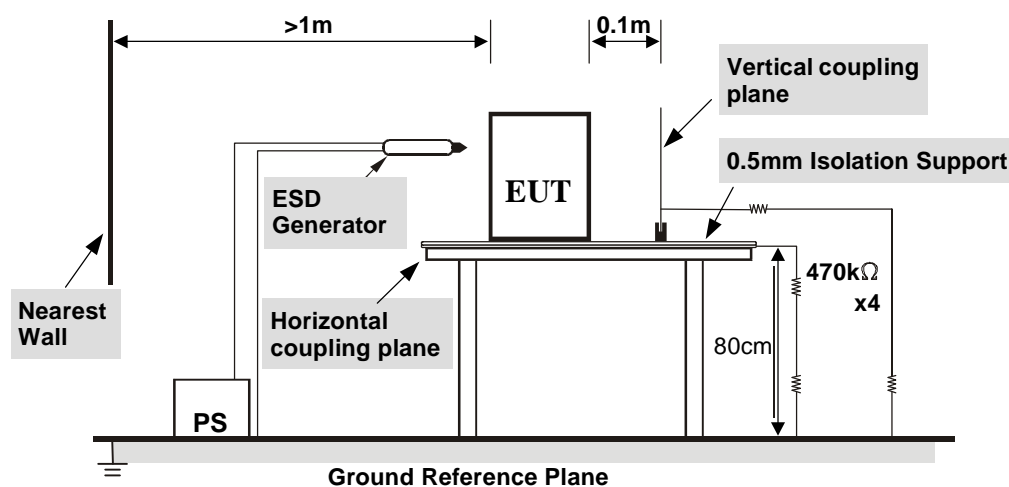

TABLE-TOP EQUIPMENT

The configuration consisted of a wooden table 0.8 meters high standing on the **Ground Reference Plane**. The **GRP** consisted of a sheet of aluminum at least 0.25mm thick, and 2.5 meters square connected to the protective grounding system. A **Horizontal Coupling Plane** (1.6m x 0.8m) was placed on the table and attached to the **GRP** by means of a cable with 940kΩ total impedance. The equipment under test, was installed in a representative system as described in section 7 of EN/IEC 61000-4-2, and its cables were placed on the **HCP** and isolated by an insulating support of 0.5mm thickness. A distance of 1-meter minimum was provided between the EUT and the walls of the laboratory and any other metallic structure.

For the actual test configuration, please refer to the related item – Photographs of the Test Configuration.

12.4 Test Results

Input Power	230 Vac, 50 Hz	Tested by	Chiming Li
Environmental Conditions	23 °C, 51% RH 1006 mbar	Test mode	Mode 1

Test Results of Direct Application

Discharge Level (kV)	Polarity (+/-)	Test Point	Contact Discharge	Air Discharge	Performance Criterion
2, 4, 8	+/-	2, 3, 6, 7	NA	Note 1	A
2, 4	+/-	4, 5	NA	Note 1	A
8	+/-	4, 5	NA	Note 2	B
2, 4	+/-	1, 8	Note 1	NA	A
2, 4	+/-	9	Note 2	NA	B

Description of test points of direct application: Please refer to following page for representative mark only.

Test Results of Indirect Application

Discharge Level (kV)	Polarity (+/-)	Test Point	Horizontal Coupling Plane	Vertical Coupling Plane	Performance Criterion
2, 4	+/-	Four Sides	Note 1	Note 1	A

Description of test points of indirect application:

1. Front side 2. Rear side 3. Right side 4. Left side

Note: 1. The EUT function was correct during the test.

2. There was flicker disturbance on the screen during the test, but self-recoverable after the test.

Description of Test Points

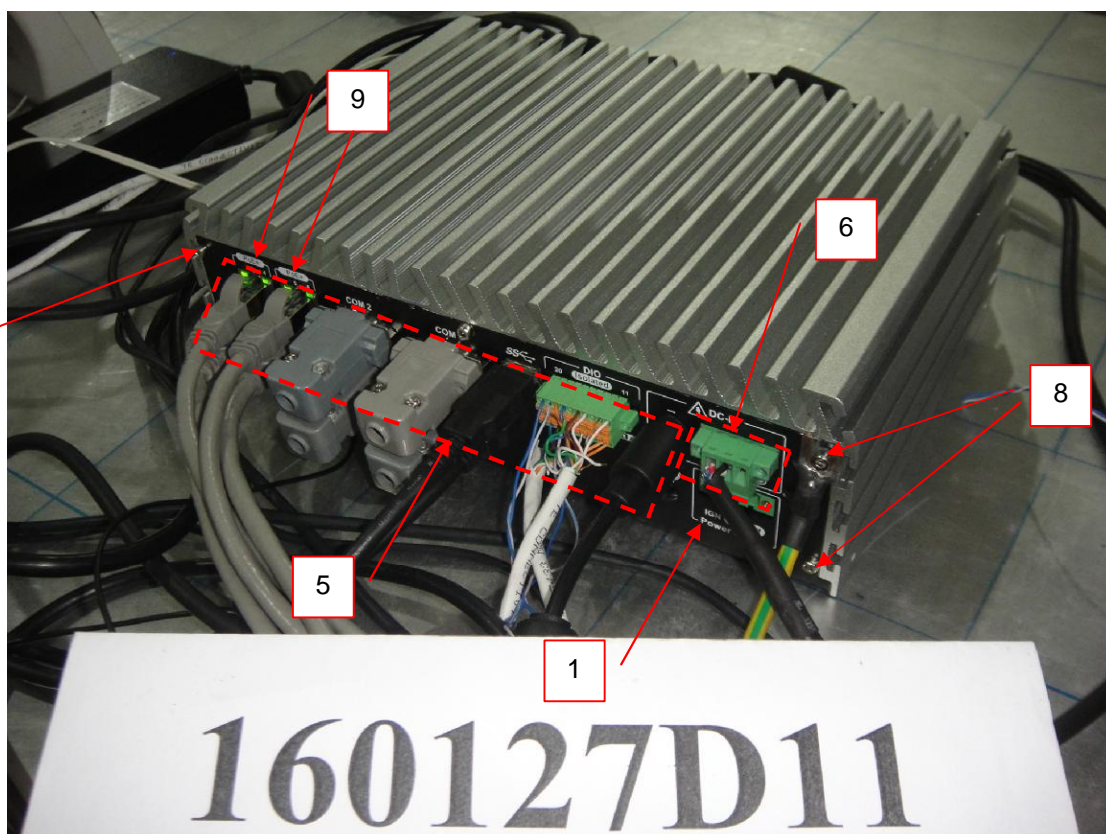
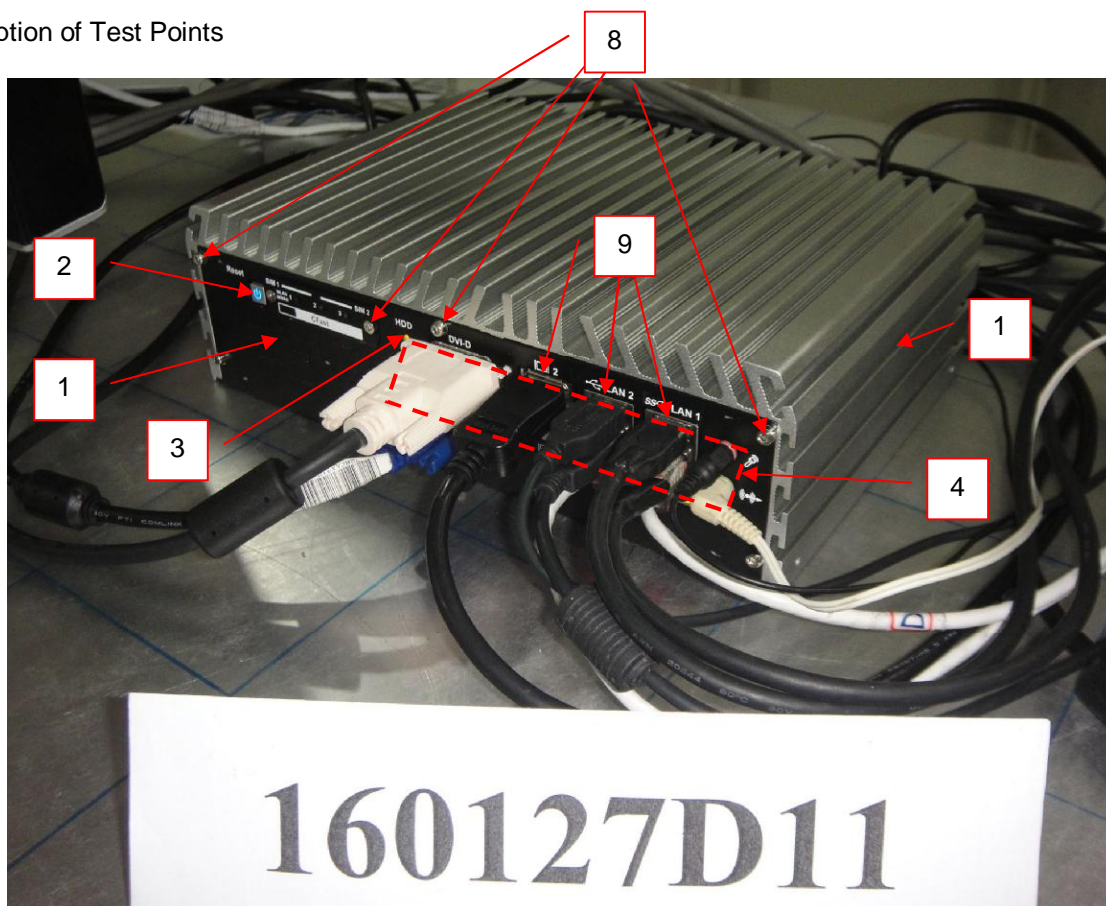



13 Radiated, Radio-frequency, Electromagnetic Field Immunity Test (RS)

13.1 Test Specification

Basic Standard:	EN/IEC 61000-4-3
Frequency Range:	80 MHz - 1000 MHz
Field Strength:	3 V/m
Modulation:	1kHz Sine Wave, 80%, AM Modulation
Frequency Step:	1 % of preceding frequency value
Polarity of Antenna:	Horizontal and Vertical
Antenna Height:	1.5m
Dwell Time:	3 seconds

13.2 Test Instruments

Description & Manufacturer	Model No.	Serial No.	Cal. Date	Cal. Due
Agilent Signal Generator	E8257D	MY48050465	Jul. 21, 2015	Jul. 20, 2016
PRANA RF Amplifier	AP32DP280	0811-894	NA	NA
TESEQ RF Amplifier	CBA1G-150	T44220	NA	NA
AR RF Amplifier	35S4G8AM4	0326094	NA	NA
AR RF Amplifier	100S1G4M3	0329249	NA	NA
AR Controller	SC1000M3	305910	NA	NA
Narda Broadband Field Meter	NBM-550	B-0872	Feb. 09, 2016	Feb. 08, 2018
BOONTON RF Voltage Meter	4232A	10180	Jun. 01, 2015	May 31, 2016
BOONTON Power Sensor	51013-4E	34870	Jun. 01, 2015	May 31, 2016
BOONTON Power Sensor	51013-4E	34873	Jun. 01, 2015	May 31, 2016
AR Log-Periodic Antenna	AT6080	0329465	NA	NA
EMCO BiconiLog Antenna	3141	1001	NA	NA
AR High Gain Antenna	AT4002A	306533	NA	NA
AR High Gain Horn Antenna	AT4010	0329800	NA	NA
CHANCE MOST Full Anechoic Chamber (9x5x3m)	Chance Most	RS-002	Feb. 05, 2016	Feb. 04, 2017
Software	RS_V7.6	NA	NA	NA

- Notes:
1. The calibration interval of the above test instruments is 12 months and the calibrations are traceable to NML/ROC and NIST/USA.
 2. The test was performed in RS Room No.2.
 3. Tested Date: Mar. 3, 2016.

13.3 Test Arrangement

The test procedure was in accordance with EN/IEC 61000-4-3.

- a. The testing was performed in a modified semi-anechoic chamber.
- b. The frequency range is swept from 80 MHz to 1000 MHz, with the signal 80% amplitude modulated with a 1kHz sine wave.
- c. The field strength level was 3 V/m.
- d. The test was performed with the EUT exposed to both vertically and horizontally polarized fields on each of the four sides.

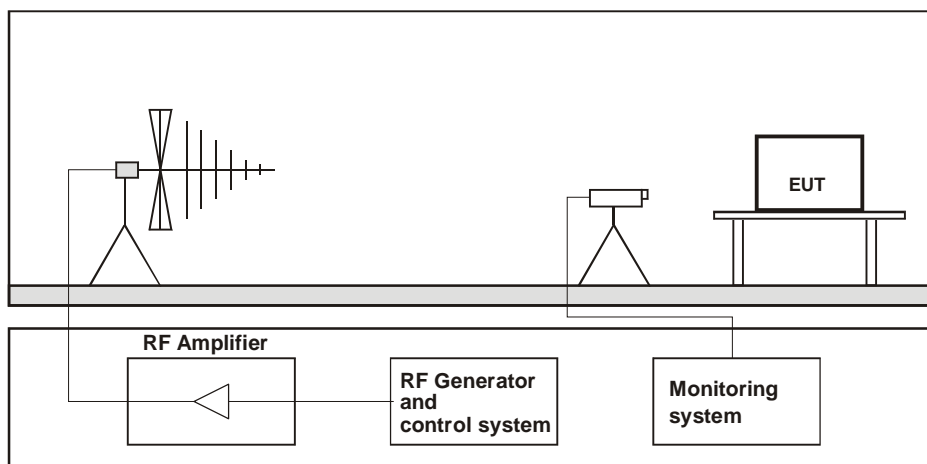

Table-top Equipment

The EUT installed in a representative system as described in section 7 of EN/IEC 61000-4-3 was placed on a non-conductive table 0.8 meters in height. The system under test was connected to the power and signal wire according to relevant installation instructions.

For the actual test configuration, please refer to the related item – Photographs of the Test Configuration.

13.4 Test Results

Input Power	230 Vac, 50 Hz	Tested by	Aga Lin
Environmental Conditions	26 °C, 64% RH	Test mode	Mode 1

Frequency (MHz)	Polarity	Azimuth(°)	Applied Field Strength		Observation	Performance Criterion
			(V/m)	Modulation		
80 -1000	V&H	0	3	80% AM (1kHz)	Note	A
80 -1000	V&H	90	3	80% AM (1kHz)	Note	A
80 -1000	V&H	180	3	80% AM (1kHz)	Note	A
80 -1000	V&H	270	3	80% AM (1kHz)	Note	A

Note: The EUT function was correct during the test.

14 Electrical Fast Transient/Burst Immunity Test (EFT)

14.1 Test Specification

Basic Standard:	EN/IEC 61000-4-4
Test Voltage:	Signal / telecommunication port: ± 0.5 kV Input DC power port: N/A Input AC power port: ± 1 kV
Impulse Repetition Frequency:	xDSL telecommunication port: 100 kHz others: 5 kHz
Impulse Wave Shape:	5/50 ns
Burst Duration:	0.75 ms for 100 kHz Repetition Frequency 15 ms for 5 kHz Repetition Frequency
Burst Period:	300 ms
Test Duration:	1 min.

14.2 Test Instruments

Description & Manufacturer	Model No.	Serial No.	Cal. Date	Cal. Due
Haefely, EFT Generator	PEFT 4010	154954	Apr. 17, 2015	Apr. 16, 2016
Haefely, Capacitive Clamp	IP4A	155173	Apr. 17, 2015	Apr. 16, 2016

- Notes:
1. The calibration interval of the above test instruments is 12 months and the calibrations are traceable to NML/ROC and NIST/USA.
 2. The test was performed in EFT Room.
 3. Tested Date: Mar. 7, 2016.

14.3 Test Arrangement

- Both positive and negative polarity discharges were applied.
- The distance between any coupling devices and the EUT should be 0.5 m for table-top equipment testing, and 1.0 m for floor standing equipment.
- The duration time of each test sequential was 1 minute.
- The transient/burst waveform was in accordance with EN/IEC 61000-4-4, 5/50 ns.

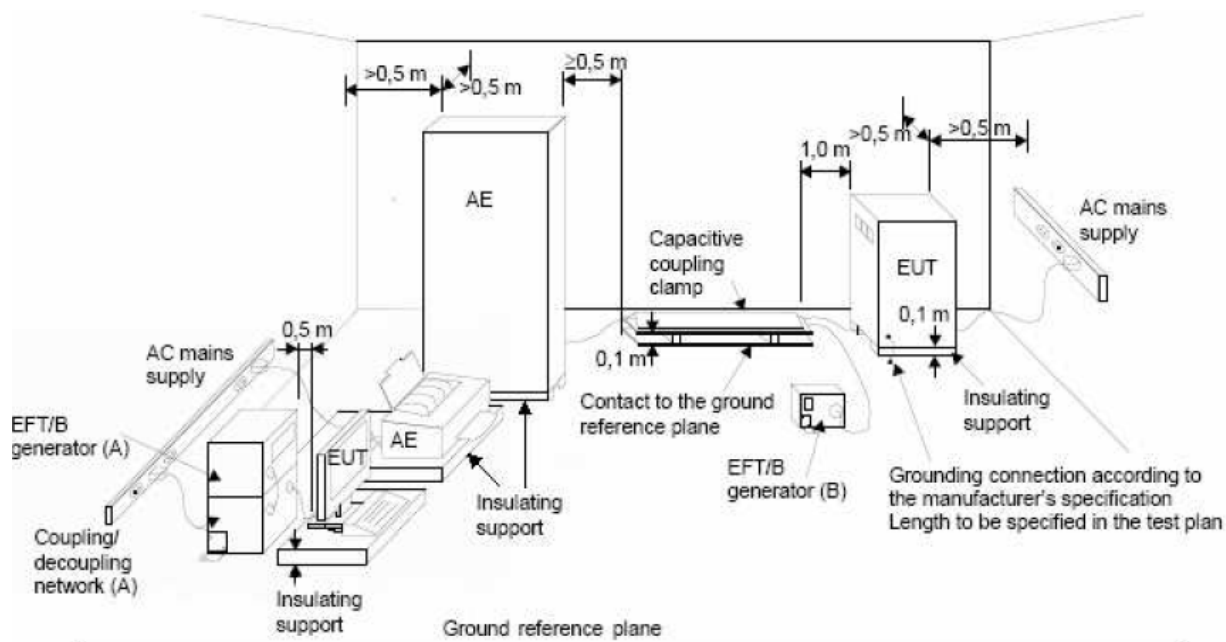

NOTE:

- (A) location for supply line coupling
- (B) location for signal lines coupling

For the actual test configuration, please refer to the related item – Photographs of the Test Configuration.

14.4 Test Results

Input Power	230 Vac, 50 Hz	Tested by	Aga Lin
Environmental Conditions	22 °C, 73% RH	Test mode	Mode 1

Input AC power port

Voltage (kV)	Test Point	Polarity (+/-)	Observation	Performance Criterion
1	L1	+/-	Note	A
1	L2	+/-	Note	A
1	PE	+/-	Note	A
1	L1-L2-PE	+/-	Note	A

Telecommunication port

Voltage (kV)	Test Point	Polarity (+/-)	Observation	Performance Criterion
0.5	UTP LAN	+/-	Note	A
0.5	STP LAN	+/-	Note	A

Note: The EUT function was correct during the test.

15 Surge Immunity Test

15.1 Test Specification

Basic Standard:	EN/IEC 61000-4-5
Wave-Shape:	Signal / telecommunication port (direct to outdoor cables*): 10/700 μ s Open Circuit Voltage 5/320 μ s Short Circuit Current Input DC power port (direct to outdoor cables*): 1.2/50 μ s Open Circuit Voltage 8/20 μ s Short Circuit Current Input AC power port: 1.2/50 μ s Open Circuit Voltage 8/20 μ s Short Circuit Current
Test Voltage:	Signal and telecommunication ports**: w/o primary protectors: N/A, with primary protectors fitted: N/A Input DC power port: Line to earth or ground: N/A Input AC power ports: Line to line: ± 0.5 kV, ± 1 kV, Line to earth or ground: ± 0.5 kV, ± 1 kV, ± 2 kV
AC Phase Angle (degree):	0°, 90°, 180°, 270°
Pulse Repetition Rate:	1 time / 20 sec.
Number of Tests:	5 positive and 5 negative at selected points

* This test is only applicable only to ports, which according to the manufacturer's specification, may connect directly to outdoor cables.

** For ports where primary protection is intended, surges are applied at voltages up to 4 kV with the primary protectors fitted. Otherwise the 1 kV test level is applied without primary protection in place.

15.2 Test Instruments

Description & Manufacturer	Model No.	Serial No.	Cal. Date	Cal. Due
TESEQ, Surge Simulator	NSG 3060	1572	May 20, 2015	May 19, 2016
Coupling Decoupling Network	CDN-UTP8	028	Aug. 20, 2015	Aug. 19, 2016
TESEQ Coupling Decoupling Network	CDN HSS-2	41009	Aug. 05, 2015	Aug. 04, 2016
TESEQ Coupling Decoupling Networ	CDN 118-T8	40386	Aug. 31, 2015	Aug. 30, 2016

- Notes:
1. The calibration interval of the above test instruments is 12 months and the calibrations are traceable to NML/ROC and NIST/USA.
 2. The test was performed in EMS Room No. 2.
 3. Tested Date: Mar. 8, 2016.

15.3 Test Arrangement

a. Input AC/DC Power ports:

The surge is to be applied to the EUT power supply terminals via the capacitive coupling network. Decoupling networks are required in order to avoid possible adverse effects on equipment not under test that may be powered by the same lines, and to provide sufficient decoupling impedance to the surge wave. The power cord between the EUT and the coupling/decoupling networks shall be 2 meters in length (or shorter).

For double-insulated products without PE or external earth connections, the test shall be done in a similar way as for grounded products but without adding any additional external grounded connections. If there are no other possible connections to earth, line-to-ground tests may be omitted.

b. Signal and telecommunication ports,

I Unshielded unsymmetrical interconnection lines:

The surge is applied to the lines via the capacitive coupling. The coupling / decoupling networks shall not influence the specified functional conditions of the EUT. The interconnection line between the EUT and the coupling/decoupling networks shall be 2 meters in length.

I Unshielded symmetrical interconnections communication lines:

The surge is applied to the lines via gas arrestors coupling. Test levels below the ignition point of the coupling arrestor cannot be specified. The interconnection line between the EUT and the coupling/decoupling networks shall be 2 meters in length.

I High speed communications lines

Prior to the test, the correct operation of the port shall be verified; the external connection shall then be removed and the surge applied directly to the port's terminals with no coupling /decoupling network. After the surge, the correct operation of the port shall again be verified.

I Shielded lines:

- Direct application,

The EUT is isolated from ground and the surge is applied to its metallic enclosure; the termination (or auxiliary equipment) at the port(s) under test is grounded. This test applies to equipment with single or multiple shielded cables.

Rules for application of the surge to shielded lines:

a) Shields grounded at both ends

- The surge injection on the shield.

b) Shields grounded at one end

- If in the installation the shield is connected only at the auxiliary equipment, test shall be done in that configuration but with the generator still connected to the EUT side. If cable lengths allow, the cables shall be on insulated supports 0,1 m above the ground plane or cable tray.

For products which do not have metallic enclosures, the surge is applied directly to the shielded cable.

- Alternative coupling method for testing single cables in a multi-shield configuration,

Surges are applied in close proximity to the interconnection cable under test by a wire. The length of the cable between the port(s) under test and the device attached to the other end of the cable shall be the lesser of: the maximum length permitted by the EUT's specification, or 20 m. Where the length exceeds 1 m, excess lengths of cables shall be bundled at the approximate centre of the cables with the bundles 30 cm to 40 cm in length.

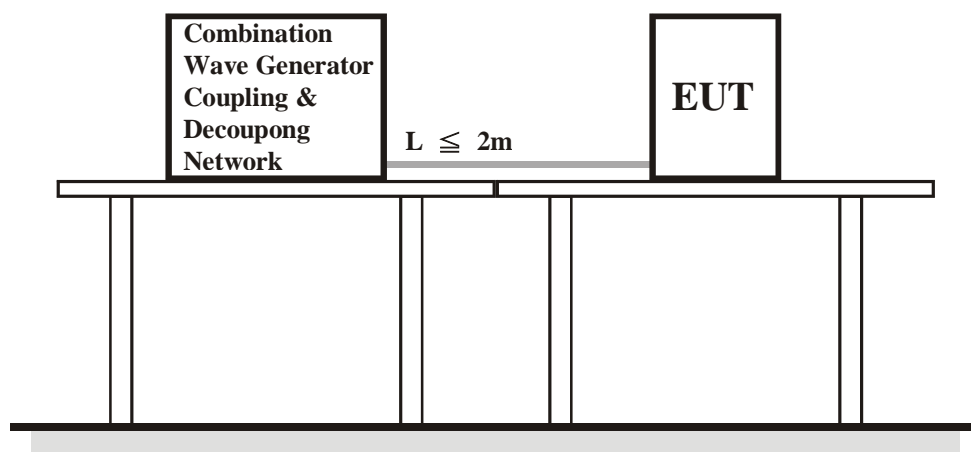

For the actual test configuration, please refer to the related item – Photographs of the Test Configuration.

15.4 Test Results

Input Power	230 Vac, 50 Hz	Tested by	Joey Liu
Environmental Conditions	25 °C, 56% RH	Test mode	Mode 1

Input AC power port

Voltage (kV)	Test Point	Polarity (+/-)	Observation	Performance Criterion
0.5, 1	L1-L2	+/-	Note	A
0.5, 1, 2	L1-PE	+/-	Note	A
0.5, 1, 2	L2-PE	+/-	Note	A

Note: The EUT function was correct during the test.

16 Immunity to Conducted Disturbances Induced by RF Fields (CS)

16.1 Test Specification

Basic Standard:	EN/IEC 61000-4-6
Frequency Range:	0.15 MHz - 80 MHz
Voltage Level:	3 V
Modulation:	1kHz Sine Wave, 80%, AM Modulation
Frequency Step:	1 % of preceding frequency value
Dwell Time	3 seconds



16.2 Test Instruments

Description & Manufacturer	Model No.	Serial No.	Cal. Date	Cal. Due
ROHDE & SCHWARZ Signal Generator	SML03	101801	Jan. 07, 2016	Jan. 06, 2017
Digital Sweep Function Generator	8120	984801	NA	NA
AR Power Amplifier	75A250AM1	306331	NA	NA
FCC Coupling Decoupling Network	FCC-801-M3-25A	48	Jun. 23, 2015	Jun. 22, 2016
FCC Coupling Decoupling Network	FCC-801-M3-25A	01022	Jun. 23, 2015	Jun. 22, 2016
FCC Coupling Decoupling Network	FCC-801-M2-16A	01047	Jun. 23, 2015	Jun. 22, 2016
FISCHER CUSTOM COMMUNICATIONS EM Injection Clamp	F-203I-23mm	455	NA	NA
FISCHER CUSTOM COMMUNICATIONS Current Injection Clamp	F-120-9A	361	NA	NA
EM TEST Coupling Decoupling Network	CDN M1/32A	306508	Jun. 23, 2015	Jun. 22, 2016
TESEQ Coupling Decoupling Network	CDN T800	34428	Jun. 23, 2015	Jun. 22, 2016
FCC Coupling Decoupling Network	FCC-801-T4	02031	Jun. 23, 2015	Jun. 22, 2016
EM TEST Coupling Decoupling Network	CDN T2	306509	Jun. 23, 2015	Jun. 22, 2016
EM TEST Coupling Decoupling Network	CDN T4	306506	Jun. 23, 2015	Jun. 22, 2016
R&S Power Sensor	NRV-Z5	837878/039	Oct. 26, 2015	Oct. 25, 2016
R&S Power Meter	NRVD	837794/040	Oct. 27, 2015	Oct. 26, 2016
TESEQ Coupling Decoupling Network	CDN M232	37702	Aug. 18, 2015	Aug. 17, 2016
TESEQ Coupling Decoupling Network	CDN M332	41258	Sep. 22, 2015	Sep. 21, 2016
TESEQ Coupling Decoupling Network	CDN M332	41256	Aug. 20, 2015	Aug. 19, 2016
TESEQ Coupling Decoupling Network	CDN T400A	28569	Aug. 17, 2015	Aug. 16, 2016
Software	CS_V7.4.2	NA	NA	NA

- Notes:
1. The calibration interval of the above test instruments is 12 months and the calibrations are traceable to NML/ROC and NIST/USA.
 2. The test was performed in CS Room No. 1.
 3. Tested Date: Mar. 2, 2016.

16.3 Test Arrangement

- The EUT shall be tested within its intended operating and climatic conditions.
- An artificial hand was placed on the hand-held accessory and connected to the ground reference plane.
- One of the CDNs not used for injection was terminated with 50 ohm, providing only one return path. All other CDNs were coupled as decoupling networks.
- The frequency range is swept from 150 kHz to 80 MHz, using the signal level established during the setting process and with a disturbance signal of 80 % amplitude. The signal is modulated with a 1 kHz sine wave, pausing to adjust the RF signal level or the switch coupling devices as necessary. Where the frequency is swept incrementally, the step size shall not exceed 1 % of the preceding frequency value.
- Attempts should be made to fully exercise the EUT during testing, and to fully interrogate all exercise modes selected for susceptibility.

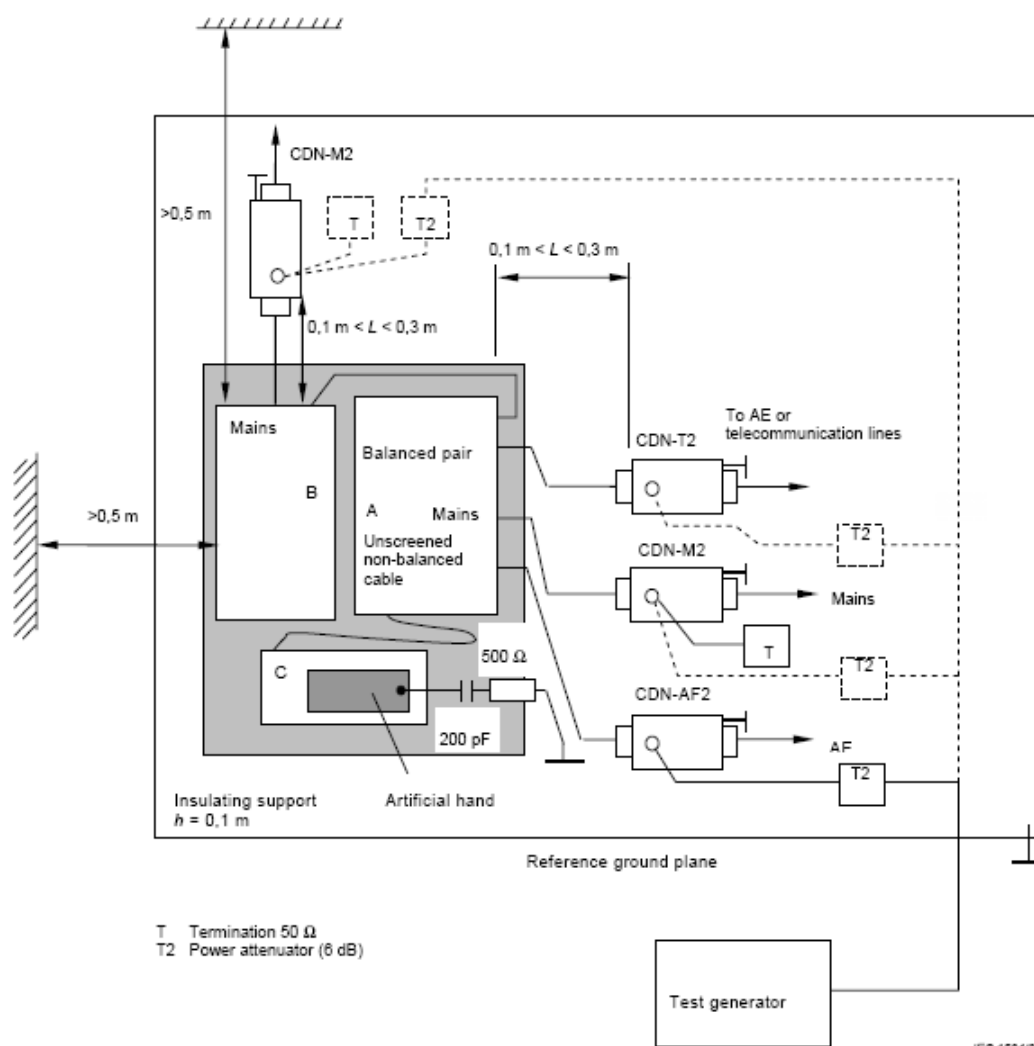

- Note:**
- The EUT clearance from any metallic obstacles shall be at least 0,5 m.
 - Interconnecting cables (≤ 1 m) belonging to the EUT shall remain on the insulating support.
 - The equipment to be tested is placed on an insulating support of 0.1 meters height above a ground reference plane. All relevant cables shall be provided with the appropriate coupling and decoupling devices at a distance between 0.1 meters and 0.3 meters from the projected geometry of the EUT on the ground reference plane.

For the actual test configuration, please refer to the related item – Photographs of the Test Configuration.

16.4 Test Results

Input Power	230 Vac, 50 Hz	Tested by	Aga Lin
Environmental Conditions	23 °C, 62% RH	Test mode	Mode 1

Frequency (MHz)	Level (Vrms)	Tested Line	Injection Method	Return Path	Observation	Performance Criterion
0.15 – 80	3	AC Power	CDN-M3	CDN-T8	Note	A
0.15 – 80	3	UTP LAN	CDN-T8	CDN-M3	Note	A
0.15 – 80	3	STP LAN	EM-Clamp	CDN-M3	Note	A

Note: The EUT function was correct during the test.

17 Power Frequency Magnetic Field Immunity Test

17.1 Test Specification

Basic Standard:	EN/IEC 61000-4-8
Frequency Range:	50Hz
Field Strength:	1 A/m
Observation Time:	1 minute
Inductance Coil:	Rectangular type, 1 m x 1 m

17.2 Test Instruments

Description & Manufacturer	Model No.	Serial No.	Cal. Date	Cal. Due
HAEFELY Magnetic Field Tester	MAG 100	083794-06	NA	NA
COMBINOVA Magnetic Field Meter	MFM10	224	Apr. 24, 2015	Apr. 23, 2016

- Notes:
1. The calibration interval of the above test instruments is 12 months and the calibrations are traceable to NML/ROC and NIST/USA.
 2. The test was performed in EMS Room No. 1
 3. Tested Date: Mar. 7, 2016.

17.3 Test Arrangement

- a. The equipment is configured and connected to satisfy its functional requirements.
- b. The power supply, input and output circuits shall be connected to the sources of power supply, control and signal.
- c. The cables supplied or recommended by the equipment manufacturer shall be used. 1 meter of all cables used shall be exposed to the magnetic field.

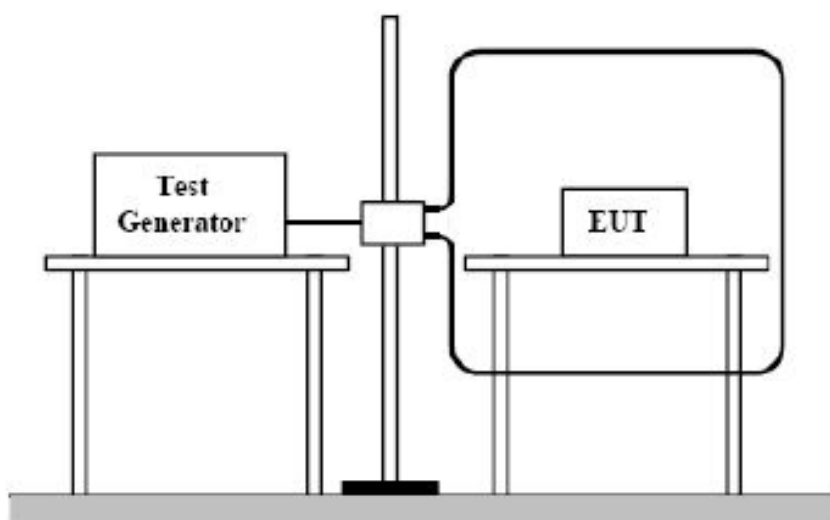

TABLETOP EQUIPMENT

The equipment shall be subjected to the test magnetic field by using the induction coil of standard dimension (1 m x 1 m). The induction coil shall then be rotated by 90 degrees in order to expose the EUT to the test field with different orientations.

For the actual test configuration, please refer to the related item – Photographs of the Test Configuration.

17.4 Test Results

Input Power	230 Vac, 50 Hz	Tested by	Aga Lin
Environmental Conditions	26 °C, 73% RH	Test mode	Mode 1

Application	Frequency (Hz)	Field Strength (A/m)	Observation	Performance Criterion
X - Axis	50	1	Note	A
Y - Axis	50	1	Note	A
Z - Axis	50	1	Note	A

Note: The EUT function was correct during the test.

18 Voltage Dips and Interruptions

18.1 Test Specification

Basic Standard:	EN/IEC 61000-4-11
Test levels:	Voltage Dips: >95% reduction – 0.5 period 30% reduction – 25 periods Voltage Interruptions: >95% reduction – 250 periods
Interval between Event:	Minimum ten seconds
Sync Angle (degrees):	0° / 180°
Test Cycle:	3 times

18.2 Test Instruments

Description & Manufacturer	Model No.	Serial No.	Cal. Date	Cal. Due
KeyTek, PQF Generator	EMC Pro	9902207	May 29, 2015	May 28, 2016

- Notes:
1. The calibration interval of the above test instruments is 12 months and the calibrations are traceable to NML/ROC and NIST/USA.
 2. The test was performed in EMS Room No. 1.
 3. Tested Date: Mar.7, 2016.

18.3 Test Arrangement

The EUT shall be tested for each selected combination of test levels and duration with a sequence of 3 dips/interruptions with intervals of 10 s minimum (between each test event). Each representative mode of operation shall be tested. Abrupt changes in supply voltage shall occur at 0 degree crossover point of the voltage waveform.

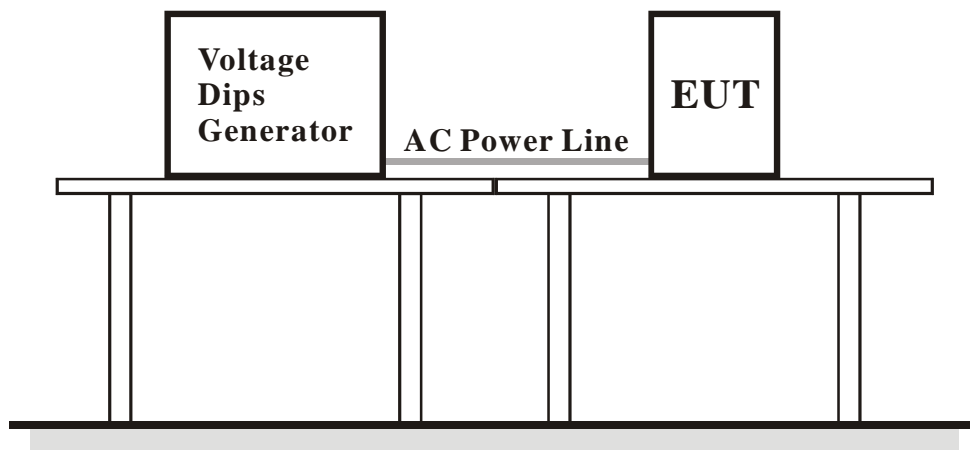

For the actual test configuration, please refer to the related item – Photographs of the Test Configuration.

18.4 Test Results

Input Power	230 Vac, 50 Hz/ 240 Vac, 50 Hz/ 100 Vac, 50 Hz	Tested by	Aga Lin
Environmental Conditions	26 °C, 72% RH	Test mode	Mode 1

Input Power for testing: 230 Vac, 50 Hz (Nominal input Voltage)					
Voltage Reduction (%)	Duration (period)	Interval (sec)	Times	Observation	Performance Criterion
>95	0.5	10	3	Note 1	A
30	25	10	3	Note 1	A
>95	250	10	3	Note 2	C

Input Power for testing: 240 Vac, 50 Hz (Maximum rated input voltage)					
Voltage Reduction (%)	Duration (period)	Interval (sec)	Times	Observation	Performance Criterion
>95	0.5	10	3	Note 1	A
30	25	10	3	Note 1	A
>95	250	10	3	Note 2	C

Input Power for testing: 100 Vac, 50 Hz (Minimum rated input voltage)					
Voltage Reduction (%)	Duration (period)	Interval (sec)	Times	Observation	Performance Criterion
>95	0.5	10	3	Note 1	A
30	25	10	3	Note 1	A
>95	250	10	3	Note 2	C

Note: 1. The EUT function was correct during the test.
2. The EUT shut down but could be restored by the operator.

19 Pictures of Test Arrangements

19.1 Conducted Disturbance at Mains Ports



19.2 Conducted Disturbance at Telecommunication Ports

LAN



PoE LAN



19.3 Radiated Disturbance up to 1 GHz



19.4 Radiated Disturbance above 1 GHz



19.5 Harmonics Current, Voltage Fluctuations and Flicker Measurement



19.6 Electrostatic Discharge Immunity Test (ESD)



19.7 Radio-frequency, Electromagnetic Field Immunity Test (RS)

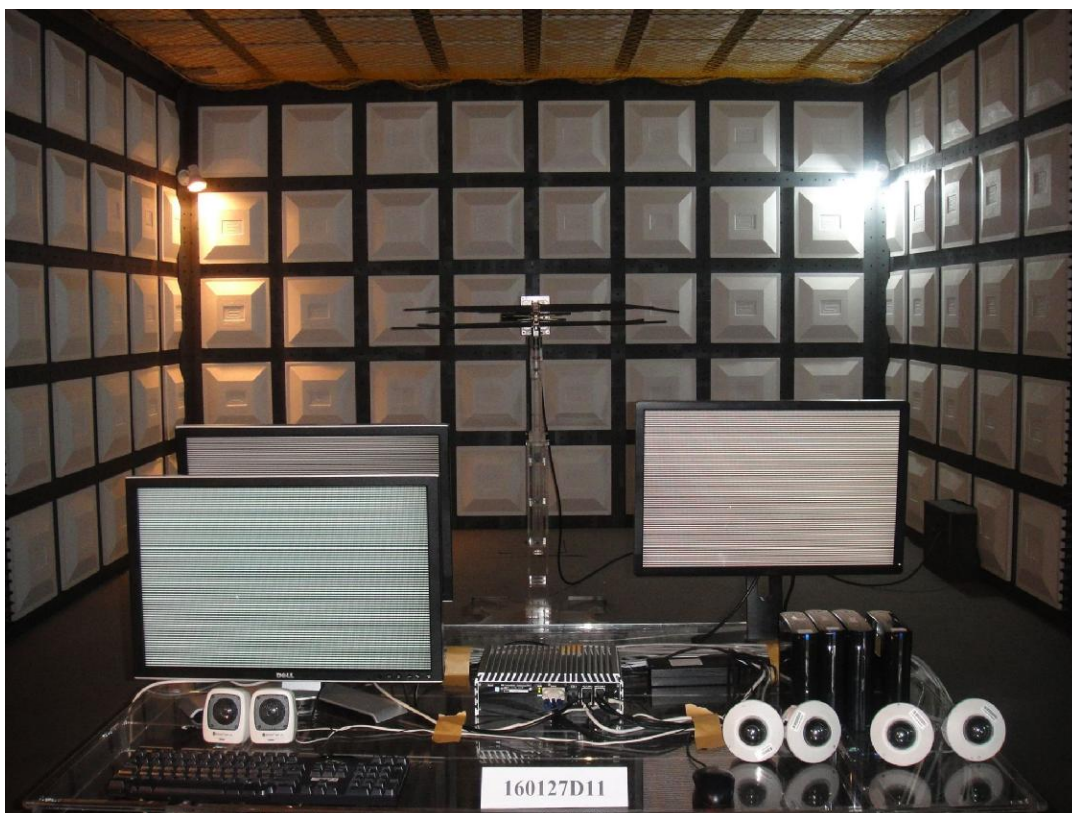

19.8 Electrical Fast Transient/Burst Immunity Test (EFT)

Mains ports



UTP LAN



STP LAN



19.9 Surge Immunity Test

Mains ports



19.10 Conducted Disturbances Induced by RF Fields (CS)

Mains ports



UTP LAN



STP LAN



19.11 Power Frequency Magnetic Field Immunity Test (PFMF)



19.12 Voltage Dips and Interruptions

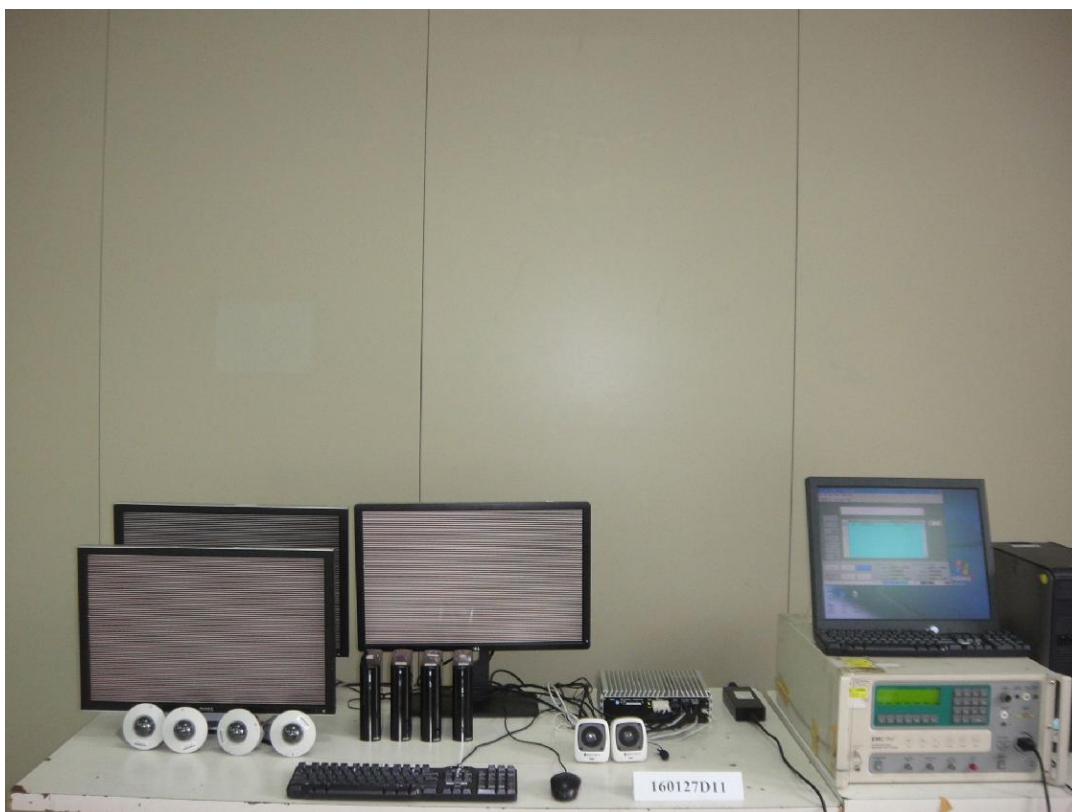

Appendix – Information on the Testing Laboratories

We, Bureau Veritas Consumer Products Services (H.K.) Ltd., Taoyuan Branch, were founded in 1988 to provide our best service in EMC, Radio, Telecom and Safety consultation. Our laboratories are accredited and approved according to ISO/IEC 17025.

If you have any comments, please feel free to contact us at the following:

Linko EMC/RF Lab

Tel: 886-2-26052180

Fax: 886-2-26051924

Hsin Chu EMC/RF/Telecom Lab

Tel: 886-3-6668565

Fax: 886-3-6668323

Hwa Ya EMC/RF/Safety Lab

Tel: 886-3-3183232

Fax: 886-3-3270892

Email: service.adt@tw.bureauVeritas.com

Web Site: www.bureauVeritas-adt.com

The address and road map of all our labs can be found in our web site also.

--- END ---